

Volume 3 Number 1 January/February, 1966

Information Display

Journal of the Society for Information Display

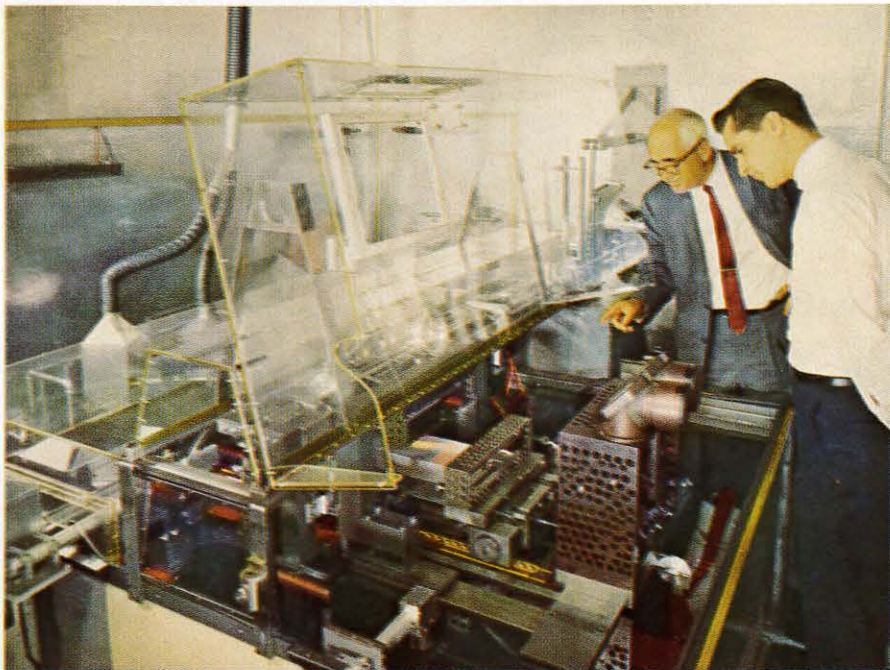



In the Spectroscopy Laboratory at MIT, Dean George R. Harrison and Stephen W. Thompson inspect interferometrically controlled ruling engine.

Laser keeps ruling engine on the track

It sounds easy, but ruling parallel tracks on a mirror surface—thousands per inch, every one parallel with every other one—can be frustratingly difficult. Lifetimes have been devoted to improving the diffraction grating, and for good reason: from this simple device, which breaks light down into its component wavelengths, has come more than nine-tenths of all that we know about the stars.

As astronomers probe deeper into space, they need ever larger gratings to improve the resolving power of their spectrographs. Some of the largest (10") and best gratings today come, surprisingly, from a 65-year-old ruling engine with warpage problems capable of causing errors 100 times the tolerable limit. The engine's secret: servo-interferometric control methods¹, recently enhanced by the use of uniphase coherent light from a Spectra-Physics Model 119 single frequency CW gas laser.

A new laser-controlled engine, designed by Dean Harrison and now taking shape at MIT, is expected to be able to rule gratings of twice the width and five times the area of today's largest. You may never need one, but if you're involved in any technology where precise measurement is important, you may someday be using a gas laser. If you'd like to know more about gas lasers, and why the

Beam from Model 119 laser, mounted in control room adjacent to engine, enters optical system via periscopes in foreground of upper photo.

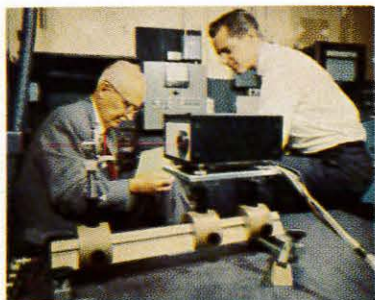

great majority of applications use Spectra-Physics CW gas lasers, write us today at 1255 Terra Bella, Mountain View, California 94041. In Europe, Spectra-Physics, S.A., Chemin de Somais 14, Pully, Switzerland.

¹ G. R. Harrison, Proc. Am. Phil. Soc. 102, 483 (1958).

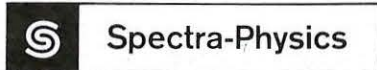

Included in the broad line of Spectra-Physics CW gas lasers is the high-power Model 125, developed to meet the requirements of information display applications. For immediate information on the Model 125 or other Spectra-Physics products, call the nearest sales engineering office listed below:

SPECTRA-PHYSICS FIELD ENGINEERING OFFICES

Spectra-Physics Inc. (home office)
1255 Terra Bella Avenue
Mountain View, California 94040
(415) 961-2550
TWX 415 969-9135

Spectra-Physics Inc.
Los Angeles, California
(213) 462-7639

Spectra-Physics Inc.
Chicago, Illinois
(312) 386-5104

Spectra-Physics, S. A.
Lausanne, Switzerland
Telephone: 28.35.35

SPECTRA-PHYSICS SALES ENGINEERING REPRESENTATIVES

Applied Measurements, Inc.
Acton, Massachusetts
(617) MI 6-7250
Hamden, Connecticut
(203) 248-5048

SBM Associates, Inc.
Rochester, New York
(716) BR 1-7430
Syracuse, New York
(315) 454-9377
Thornwood, New York
(914) 769-1811
Union, New Jersey
(201) 687-8737

Sonco
King of Prussia, Pennsylvania
(215) 265-3250
Camp Hill, Pennsylvania
(717) SO 1-0577
Eatontown, New Jersey
(201) 542-1441

Electronic Marketing Associates
Wheaton, Maryland
(301) 946-0300
Timonium, Maryland
(301) 825-0300

Barnhill Associates
Denver, Colorado
(303) 934-5505
Albuquerque, New Mexico
(505) 265-7766
Dallas, Texas
(214) AD 1-2573
Houston, Texas
(713) MO 6-4188
Scottsdale, Arizona
(602) 947-5493

Allan Crawford Associates, Ltd.
Downsview, Ontario
(416) 636-4910
Ottawa, Ontario
(613) PA 5-1288
Montreal, Quebec
(514) RE 9-6776



This is the BCD decoder that ends make/buy decisions

Many users seem to think so.

We've built our numeric readout (the noteworthy NIXIE® tube, naturally!) into a handsome, compact package that not only gives you dependable low-level BCD-to-decimal conversion, but also enhances your most elegant design.

Most important, our BIP-8211P readout assembly carries a price tag so low that the savings in design, development, production, and testing will convince even the most parsimonious do-it-himselfer to reach for a P. O. instead of a slide rule.

Convenience? The decoder socket packs can be mounted in one of our bezel assemblies that handles up to 15 digits, mounts into your front-panel opening with just two screws, accommodates decimal points and colons.

Flexibility? It's odds-on that your own BCD circuits will drive the BIP-8211P without modification. But we also offer optional versions which accept just about any form of BCD, or one that gives you straight decimal-to-decimal driving, should that be what you need.

Reliability? Continuing environmental and life testing add up to dependable operation in severe environments of temperature, shock and vibration. All this and an enthusiastic Zero Defects Program, too!

Availability? We've tooled up a new production line that's turning out BIP-8211P modules in quantities large enough to make shipment possible in an interval no longer than the time it takes to process the paperwork. Need them even faster for bread-boarding or prototyping? They're priced low enough to order them now, and have them in arm's reach.

Got a BCD-decoding requirement? Leave it to Burroughs! You'll be glad—so will your comptroller—so will the user.

Write or call for full information.

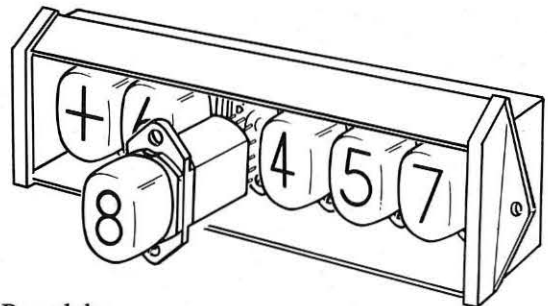

Burroughs Corporation

ELECTRONIC COMPONENTS DIVISION

PLAINFIELD, NEW JERSEY 07061

BIG, BOLD, ANGULAR NUMERALS

FOR *SUPERIOR* LEGIBILITY
with **RUGGED CONSTRUCTION**
and **LONG LIFE LAMPS**
for

UNMATCHED RELIABILITY



CAPTIONS are displayed as programmed in this auxiliary module.

DIALCO READOUTS ARE ADAPTABLE

MODULAR

- Decimal point, comma and colon optional in any module
- Modules for **CAPTIONS** and **PLUS-MINUS**
- Simple bracket provides common base

ALL POWER VOLTAGES

- 14-16 volts or 24-28 volts
- 150-170 volts (120V AC, full wave rectified)

STANDARD FULL SIZE LAMPS

- Long life neon
- 100,000 hour incandescent
- Obtainable everywhere

ALL INPUT SIGNALS

- Seven line, DIALIGHT display code
- Straight decimal
- Binary coded decimal

OFF THE SHELF—IN STOCK NOW

FOR BINARY INPUT

Integral Translator-Driver

The Module illustrated is typical of those provided with translator-driver for BCD input. Most logic levels are readily accommodated. Memory may be included.

When space back of the panel is small, the circuit board is furnished as a separate unit for offset mounting.

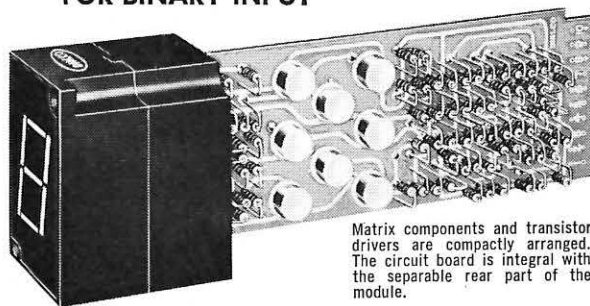

Matrix components and transistor drivers are compactly arranged. The circuit board is integral with the separable rear part of the module.

For complete data, request current catalog.



Foremost Manufacturer of Indicator Lights

DIALIGHT CORPORATION

60 STEWART AVENUE, BROOKLYN, N.Y. 11237 212 HYACINTH 7-7600



11168 Santa Monica Blvd.
Los Angeles, Calif. 90025
(213) 892-1087

OFFICERS

James Redman President
William P. Bethke..... Vice President
William V. Taylor..... Secretary
Sherman H. Boyd..... Treasurer

Executive Secretary

Dr. H. R. Luxenberg

REGIONAL DIRECTORS

Northeast Region George J. Chafaris
Carl Machover
Solomon Sherr

Southeast Region..... B. J. Lohr
Raymond Sabehe
James H. Howard

Central Region..... Richard M. Beindorff
Victor Bernin
Arthur B. Collins

Western Region..... Phillip Damon
David K. Robbins
R. E. Turnage, Jr.

COMMITTEE CHAIRMEN

Publications..... Rudolph L. Kuehn
Definitions & Standards..... Dr. Carlo P. Crosetti
Honors & Awards..... Dr. Ruth M. Davis
Membership Philip Damon

EDITORIAL ADVISORY BOARD

Mr. William Ross Aiken
Dr. Edith M. Bairdain
Mr. William P. Bethke
Dr. Carlo P. Crocetti
Dr. Ruth M. Davis
Mr. Theodore Hamburger
Dr. H. R. Luxenberg
Mr. Petro Vlahos
Dr. A. M. Zarem

Information Display

Published bi-monthly by
Information Display Publications, Inc.
647 North Sepulveda Boulevard
Bel Air, Los Angeles, Calif. 90049
(213) GR 6-4711

[Correspondence regarding advertising, reprints and non-membership subscriptions should be directed to the above address.]

EDITORS & PUBLISHERS..... Martin H. Waldman
Hal Spector

FEATURE EDITOR..... Robert Mount
NEWS EDITOR..... Lew Darling
ART DIRECTOR Roger Boos
PRODUCTION MANAGER Deborah Weiss
CIRCULATION MANAGER..... Carol Ingalls
ADVERTISING..... Donald Meeker
Ivan Berkoff

CLOSING DATES

Editorial closing date is fifteenth day of the month preceding month of issue. Advertising closing is first day of the month of issue.

CHANGE OF ADDRESS

To change address, send old mailing label imprint as well as new address. Allow 30 days for change.

SUBSCRIPTIONS

No charge to members of the Society for Information Display. All others \$12 per year. \$20 for two years. Payable in advance.

©1966 BY INFORMATION DISPLAY PUBLICATIONS, INC. ALL RIGHTS RESERVED. REPRODUCTION IN WHOLE OR PART WITHOUT WRITTEN PERMISSION IS PROHIBITED.

CONTROLLED CIRCULATION POSTAGE PAID
AT LOS ANGELES, CALIFORNIA



Picture above shows display console with its associated scanner and control cabinets. Link Waveform Display/Analyzer is used on line with 7040/7094 computer at Ballistics Systems Division, USAF.

New LINK Waveform Display/Analyzer— precision film reading and recording with one machine.

Here is a new graphic input/output device that can help reduce computer time and programming costs significantly. The Waveform Display/Analyzer allows real-time access to information and immediate updating and analysis.

You can change the display with a light pen and keyboard and request further action from the computer without the assistance of a programmer.

The light pen lets you alter, add and delete data. You can move, enlarge and reduce images, plot graphs, and label displayed information. Problems can be altered for further analysis. It is not only a problem-solving tool—it's a system for producing new designs.

The light pen saves time and cost by eliminating the need for an output record, thereby cutting down on equipment and producing answers more quickly.

AND THESE OTHER FEATURES—

- Scan a film image or waveform and digitize the data.

- Display data and images on a high-resolution CRT.
- Store computer output data on film in black-and-white or a 16-level gray scale.
- Handle large amounts of information by film scanning—(1024 x 1024-bit matrix with 16,380 x 16,380 also available).
- Buffer system storage capacity 1024 words, 36 bits each.
- All solid-state circuitry.
- Utilizes interchangeable film transports making it possible to use 16mm, 35mm and 70mm film in both the read and record mode.

The Waveform Display/Analyzer can operate as a single unit with one small binary computer or as one of several time-shared units on a large host machine.

For an informative brochure, write to Advanced Products Sales, General Precision, Inc., Link Group, 1451 California Ave., Palo Alto, Cal.

**GENERAL
PRECISION INC**
LINK GROUP

YOKE SPECIALISTS

COMPLETE LINE for every Military and Special Purpose in PRODUCTION QUANTITIES or CUSTOM DESIGNED to your specific requirement.

- Yokes for all $\frac{7}{8}$ ", $1\frac{1}{8}$ ", $1\frac{1}{2}$ " and $2\frac{1}{8}$ " neck dia. CRT's—only a few representative types are illustrated.
- Core materials to suit your requirements.
- Special test instruments can establish your yoke deflection parameters to an accuracy of $\pm 0.1\%$.
- Special designs for color displays.
- Yokes available with series aiding field design or with parallel (bucking) field design.



Types V21 & V22

VIDICON YOKES & FOCUS COILS for 1" Vidicons IN VOLUME PRODUCTION NOW. For both commercial and military applications. Engineering Service available. Special designs for all types of 1" vidicons including electrostatic focus magnetic deflection types. For full technical details request catalog page.



Type P7



Type P8

ANTI-PINCUSHION DEVICES, both PM and EM types

Eliminates CRT geometrical picture distortion. Type P7 permanent magnet anti-pincushion assembly requires no current... occupies small space... easily adjustable... mounts directly on standard yokes... available in wide choice of magnet strengths with tight tolerances. Type P8 electromagnetic coil anti-pincushion assembly has very high precision construction... allows convenient front panel adjustment. For full technical details request catalog page.



Type Y69

TWEETER YOKE for $1\frac{1}{2}$ " neck dia. CRT's.

For generating characters in alpha numeric displays. Matches solid state circuitry. Eliminates electrostatic diddle plates. Frequency response up to 10 mc with a Q of 15. For full technical details request catalog page.



Type Y58 Series
Up to 40° , 52° , 70° and 90° deflection angles.

STATOR YOKES for $1\frac{1}{2}$ " neck dia. CRT's.

For time shared sweep displays and other stator yoke applications. Available with high efficiency push-pull windings.



Type Y65
Up to 70° deflection angle

MINIATURE PRECISION ENCAPSULATED PUSH-PULL YOKE for $\frac{7}{8}$ " neck dia. CRT's.

Available in wide range of impedances and windings for both transistor drivers and vacuum tube circuits. Features electrically balanced windings with equal deflection sensitivities. Close angular tolerances of the display are achieved by precise construction. Epoxy encapsulated to withstand extreme environments. For full technical details request catalog page.



Type Y25-R Series
Up to 52° and 70° deflection angles

COMPACT ROTATING COIL YOKES for $1\frac{1}{2}$ " neck dia. CRT's.

For Radar Plan Position Indicator and all other rotating coil applications. Versions available with dc off-centering coils. Complete in aluminum housing containing deflection coil, slip rings and brush assembly, drive gear and bearing for easy installation into any equipment design. Only $3\frac{3}{4}$ " OD x $2\frac{1}{16}$ " long. For technical details request catalog page.



Type Y15 Series
Up to 52° , 70° or 90° deflection angles

PUSH-PULL OR SINGLE ENDED YOKES for $1\frac{1}{2}$ " neck dia. CRT's.

For military and oscilloscope applications requiring maximum resolution, low geometric distortion and high efficiency. Square core design with parallel opposed magnetic field. Available with extremely sensitive windings. For full technical details request catalog page.



Type Y16-6
Up to 60° deflection angle

HIGH SPEED PUSH-PULL YOKES for $1\frac{1}{2}$ " neck dia. CRT's.

Ideal for high speed data presentation and oscilloscope applications using push-pull circuits requiring exceptionally high deflection rates, low distortion and high efficiency. Available with medium to very low impedance coils. Low stray capacity. Series magnetic field design. For full technical details request catalog page.

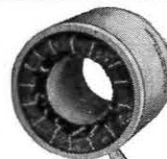

Type Y66
Up to 60° deflection angle

LARGE I.D. YOKES for $2\frac{1}{8}$ " neck dia. CRT's.

Designed especially for charactron CRT's to give minimum twisting or distortion of characters. Suitable also for precision displays with other types of $2\frac{1}{8}$ " neck dia. CRT's.



Type F10

PRECISION ELECTROMAGNETIC FOCUS COILS for $\frac{7}{8}$ ", $1\frac{1}{2}$ ", $2\frac{1}{8}$ " and other neck dia. CRT's.

All designed for ultimate focus. Negligible effect on spot size when properly aligned to beam. Static types (all sizes)—low power or high power. Dynamic-static combinations ($1\frac{1}{2}$ " neck dia.)... compact single gap design... or double gap design to simplify circuitry by eliminating coupling between static and dynamic coils. Wide range of coil resistances available. For full technical details, request catalog pages. Please specify your CRT and beam accelerating voltage.

For engineering assistance in solving your display problems, please contact our nearest representative:

Boston-New England: 762-3164
 New York: 695-3727
 Philadelphia Area: 789-2320
 Washington-Baltimore Area: 277-1023
 Florida Area: 813, 347-6183
 Los Angeles: 283-1201

Syntronic INSTRUMENTS, INC.

100 Industrial Road, Addison, Ill. (20 miles west of Chicago), Phone (Area 312) 543-6444

Specialists in Components and Equipment used with Cathode Ray Tubes

SALES OFFICES

ALBUQUERQUE

Bill Bains
505 247-8384

SAINT LOUIS

Bob Crosby
314 838-6122

HUNTSVILLE

Harlan Dybdahl
205 536-4970

SAN JOSE

Robert Elliott
408 257-3660

NEW YORK

William Lally
212 751-4756

VAN NUYS

Jerry Lane
213 781-7100

WASHINGTON, D.C.

Jack Primavere
202 483-6656

BOSTON

Jim Sokoloski
617 969-8246

ORLANDO

Rice White
305 423-4838

DALLAS

John Woodfill
214 231-1550

OTTAWA

Pat Philliban
613 825-3045

**Nationwide Customer
Service Engineering**

PLOTTING FOR FUTURE PROFITS

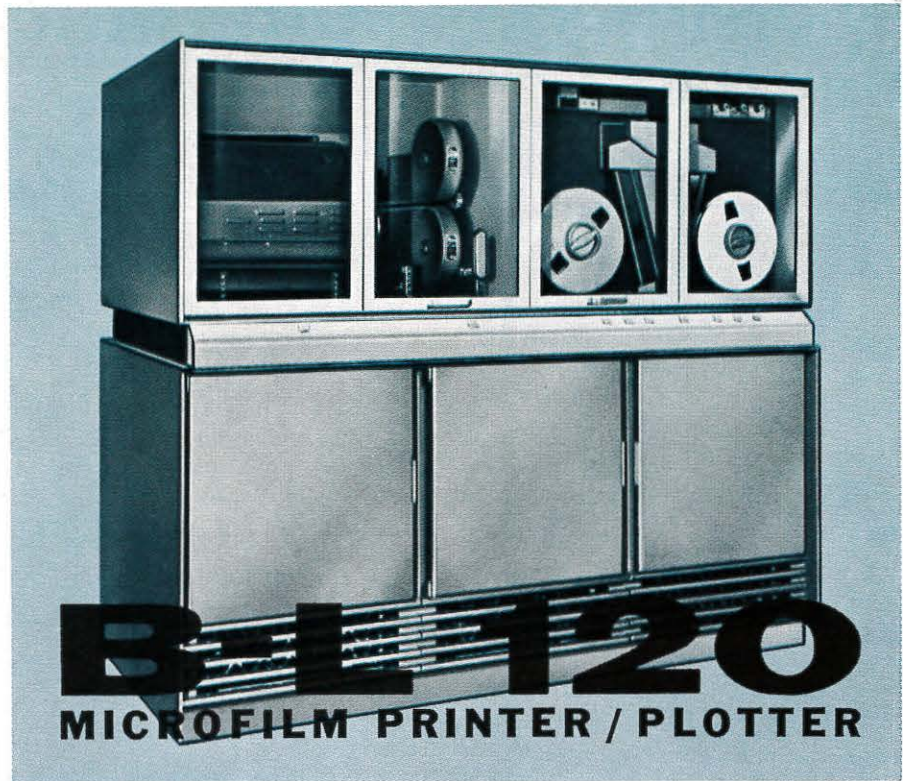

Independent, off-line operation without tape transports • High resolution printing and plotting • 35mm or 16mm microfilm output • Minimum throughput of 120 frames per minute • Vector and axes drawing • Simultaneous film and hard copy printing • 4-second "quick look" and report-quality printing • Superimposed forms printing • Convenient modular system expandability

LOOKING FOR A \$200,000 SYSTEM LIKE THIS?

Sorry, you won't find it. The only second generation microfilm printer/plotter is less than half that price. The best \$200k systems may match some of the B-L 120 features above. But no other system can also offer these exclusive B-L 120 advantages:

OFF-LINE OPERATION CUTTING TAPE TRANSPORT COSTS • 7-TRACK AND 9-TRACK COMPATIBILITY • UP TO 128-192 INPUT CHARACTER CONTROL • THE ONLY SILICON SOLID-STATE SYSTEM AVAILABLE

These are just a few of the performance advantages which can slash your operating costs. Write or phone today to find out more fully how the B-L 120 is designed to save thousands of dollars per month in your printing and/or plotting application.



benson-lehner corporation

14761 CALIFA STREET, VAN NUYS, CALIFORNIA • 781-7100

Information Display

Journal of the Society for Information Display

CUSTOM CRT DISPLAYS



Typical Example:

Dual-gun recording storage tube, scan converter

Description:

A high resolution, completely transistorized system. Applications include scan conversion, video storage and analysis and random access storage.

We specialize in designing and building Custom CRT Systems to meet exacting precision and performance requirements.

Recent design projects include:

- High resolution line scan displays
- Airborne militarized radar displays
- Scan conversion
- Computer displays
- Film scanners and printers

Your requirements studied at no obligation. Call or write:



377 ELLIOT ST., NEWTON UPPER FALLS

MASSACHUSETTS / TEL. 617 • 969-6510

ARTICLES

Methodology for the Definition of a Space Vehicle Display System

by Neil J. ArntzPage 22

A methodology is presented for a systems approach to the definition of a display system for space vehicles. Mission objectives and the role of man in the mission are used as the basis for examining display requirements.

Two-Color Display System

by John S. FrostPage 40

Two-color display techniques, where two primaries are used to generate a near full spectrum of mixtures, are described in detail. Theoretical background presented includes principles of chromatic adaptation and induced colors.

Intensity-Modulated Recorders

by Harold KlipperPage 45

Discusses the side-by-side arrangement of successive sweeps in order to permit immediate interpretation of the time-history of large quantities of data in the intensity-modulated display, and improved signal detection below noise.

A Computer Time-Shared Display

by Stephen B. GrayPage 50

Describes a display system which eliminates repeated loops of display-generating instructions with frame rate independent of quantity of material in the display, retaining light pen detection and capability directly through the display console.

FEATURES

GUEST EDITORIAL	Page 20
ID AUTHORS	Page 53
ID READOUT	Page 54
ON THE MOVE	Page 60
ID CORRESPONDENCE	Page 63
ID PRODUCTS	Page 64
NEW LITERATURE	Page 68
SID SUSTAINING MEMBERS	Page 70
ID ADVERTISERS	Page 70

THE COVER

Abstract view by Artist John Desatoff, TRW Systems, portrays the elements of color integrated, yet distinctive, suggesting graphically all that we perceive in color as a basis for suggestion, interpretation, motivation, understanding.

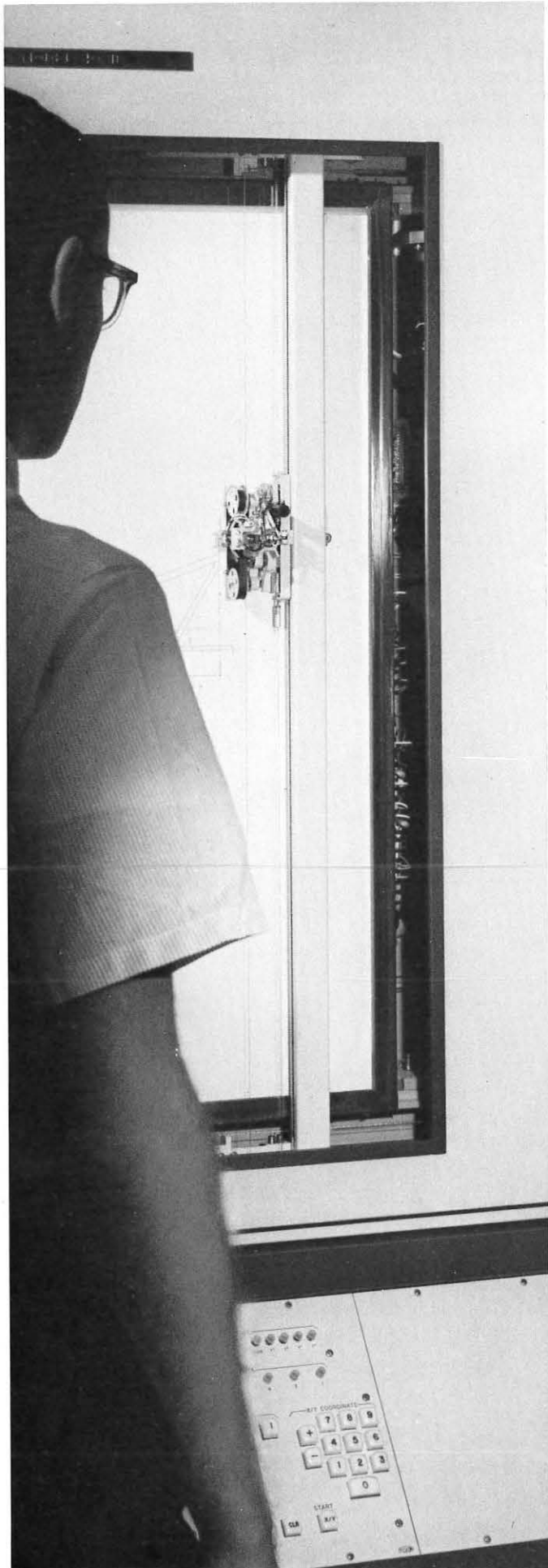

See how much more your data display dollar will buy...

**Compare Milgo's new 30"x30"
Vertical - plotting X-Y Recorder
feature for feature.**



Compare it for speed. Repeatability. Accuracy. Reliability. Plot visibility. Add-on flexibility. Versatility. Quality. Floor space. Delivery time.

The Milgo solid-state 4021D X-Y Recorder accepts on-line digital inputs from any digital computer; off-line inputs from magnetic tape, punched paper tape, punched cards, a manual keyboard or an analog source. The pen/printer draws lines, curves and point-plots; it symbol prints with a 50 character symbol printer. Pen and symbol printer interchange electronically in milliseconds. The pen/printer has a slew of 30 ips, with a continuous writing speed of 20 ips. The pen/printer point-plots in either pen or symbol mode at 500 ppm. It prints a random selection alpha-numeric character at 300 per minute. The plotting surface is evenly back-lighted by a variable powerstat control. Plots are clearly visible for 10 feet or more. The complete unit only occupies a 50 by 18 inch floor space.

The 4021D was developed and is produced to military standards of quality and reliability. It is rugged and of modular construction. Installed and operating, it has the lowest feature-for-feature price tag of any 30 by 30 inch plotter available to industrial and commercial users.

Take a cold, hard look, for instance, at the symbol printer and its integral pen and inking system.* The complete unit is $\frac{1}{3}$ to $\frac{1}{4}$ smaller than competitive units. It has no dangling umbilical cord. Pens are low-mass, solenoid actuated. Capillary action prevents spilling at any slew speed or acceleration, and the ink reserve can be filled without disassembly. Ink supply is indicated visually. The arm, only $1\frac{1}{4}$ inches wide, is servo-motor driven at both top and bottom. It is ball-bearing mounted on stainless steel rails, precision ground to within 0.004 inch. It allows accelerations of 400 ips² in both X and Y; provides static accuracy within $\pm 0.05\%$ of full scale, and repeatability of $\pm 0.02\%$.

Milgo offers analog and/or digital recorders in vertical or horizontal models with plotting surfaces up to 45 x 60 inches. If you need to know what your "data-display dollar" can buy, call Tom Thorsen, Marketing Department.

*U.S. Patent No. 3,120,214.



Milgo Electronic Corporation

7620 N.W. 36th Avenue, Miami, Florida 33147.
Phone: 305 691-1220. TWX: 305 696-4489.

Professional Personnel Applications Now Being Accepted.

Can your projection light source measure up to an OSRAM XENON bulb?



OSRAM XENON PLUS FACTORS

- Excellent color rendering qualities
- No color temperature change throughout bulb life
- Controllable light output within rated bulb power levels
- Bulb life exceeding 2,000 hours
- Competitive cost-per-hour operation
- Highest quality optical quartz
- Repeatable precision mechanical tolerances

Replacing old-style light sources with Osram Xenon short arc bulbs is much simpler than the switch from silent to sound films—but just as wise. This is the trend among film processors, studio screen rooms, and individual theatre owners.

Postponing your change to Osram Xenon costs you money. Review the Osram plus factors to see why. Doesn't each feature add up to efficiency and reliability? The end result is maximum screen brightness and sharp definition at economical cost-per-hour operation.

The Osram line provides a wattage for every application: 250, 500, 1000, 2000, 3000, and 5000 watts. Recommended power supplies and igniters or complete lamp house and projector manufacturers available on request.

*For data and prices write
Macbeth Sales Corporation,
exclusive United States distributor
for Osram Xenon bulbs.*



**MACBETH
SALES
CORPORATION**

NEWBURGH, N. Y. 12553

FOR THE APPAREL INDUSTRY: AUTOMATIC PATTERNS



MISS UNIVERSE, Aparsa Hongsakula of Thailand, is shown with CalComp equipment which produced the pattern for her swimsuit. Catalina, Inc. has leased the equipment for commercial use at \$3,000 per month.

Another industry has learned that a computer combined with CalComp plotting equipment can speed production and increase operating efficiency.

Catalina, Inc. has demonstrated that a sample size swimsuit pattern can be "size graded" (modified and produced in various sizes) in about 1/6th the time required manually. One man in one day grades a maximum of 2 swimsuit patterns. A computer and CalComp's Curve Follower/Plotter grades a minimum of 12 patterns in a day—automatically and with precise accuracy.

The Curve Follower/Plotter, leased by Catalina, Inc. at \$3,000 per month, eventually will be followed by an automatic "marker," now being perfected by CalComp to optimize the placement of pattern parts on material for maximum use of cloth.

The automatic pattern is but one way the CalComp

equipment will benefit the apparel industry. "Piece work" efficiency—relating wages to time—will be plotted as a cost control tool. Sales charts of forecasts measured against current orders will provide a graphic hedge against over-production.

CalComp pioneered the development of automatic plotting of charts, graphs, maps or drawings from computer data—providing pictorial presentations instead of extensive, and often less meaningful, numeric or alphabetical listings. Among the many applications today: traffic studies, weather maps, brain waves, mechanical drawings, oil field contour maps, highway profiles and jet engine performance curves.

If you own, or have access to a computer, chances are you need a CalComp plotter, too. Write "Marketing" for further details.

CALCOMP
STANDARD OF THE PLOTTING INDUSTRY

CALIFORNIA COMPUTER PRODUCTS, INC.
305 Muller Avenue, Anaheim, California • (714) 774-9141

NEW MICRO SWITCH KB makes it practical for you to customize any keyboard or panel

KB gives you a complete new set of modular switch/display keyboard components—makes it practical for you to design and assemble a custom man/machine interface for each individual keyboard. KB is a totally new concept in panel design with *modular* components like these:

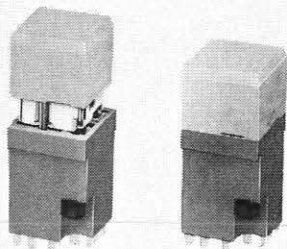
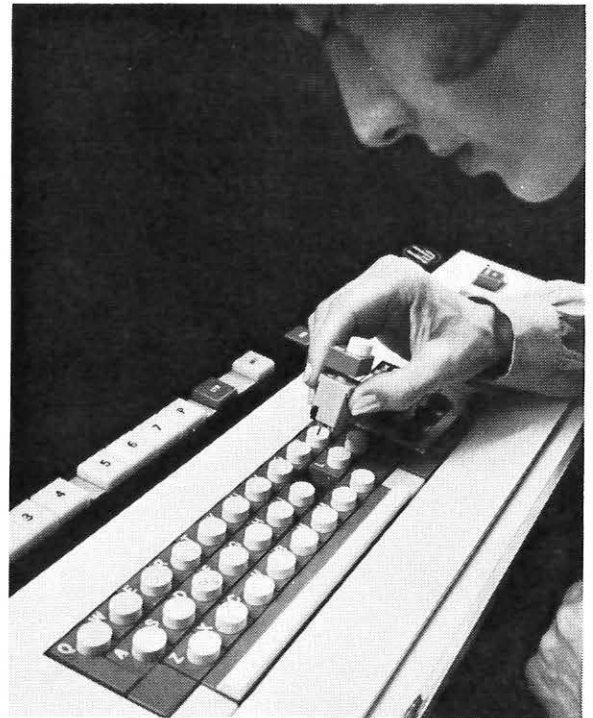

Plug-in Power Switches and Indicators with lighted display, wide variety of button color combinations. Two- or four-pole, momentary or alternate action switches.

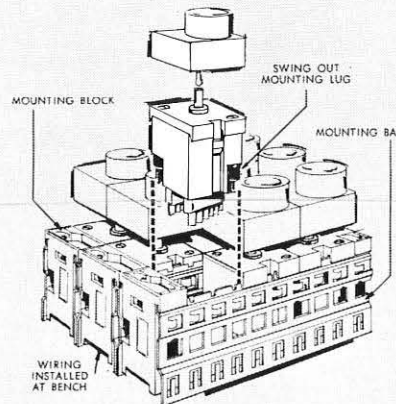

Unique Mounting Matrix Modules allow you to bench-assemble a complete keyboard matrix without special tools. Assembly, encoding and wiring may be done at the bench before the keyboard is installed.



Plug-in Encoding Switches with up to eight output bits in each. Up to 256 possible code combinations may be set up within the switch using simple encoding strips. Electrical monitor and delayed strobe. Wide variety of button color combinations.

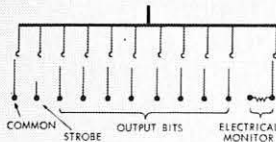

Contact Arrangement. The common and electrical monitor circuits are made first, followed by the output bits, and the strobe circuit which tells other equipment, "All circuits made and ready." ("Repeat" function optional.)

For the first time, KB allows you to arrange all switches and indicators in only *one* panel cutout. You can now do all your encoding at the switches. Plug-in or lift-out switches without disturbing adjacent units. Use *modular* interlock components for bail-in or lockout systems.

KB now makes it practical for you to customize every keyboard or control panel. KB saves on engineering time, tooling costs, assembly costs, panel space and weight.

Call a MICRO SWITCH Branch Office for a demonstration. Or, write for literature.

MICRO SWITCH
FREEPORT, ILLINOIS 61033
A DIVISION OF HONEYWELL
IN CANADA: HONEYWELL CONTROLS LIMITED, TORONTO 17, ONTARIO

IBM's new Basic Operating System is not really basic.

IBM's new Basic Operating System is a unique programming support package designed for the small and intermediate size SYSTEM/360.

It contains a full range of processing programs and control programs that enable you to get big system capabilities from your moderate sized installation.

BOS is similar to other larger IBM Operating Systems that have been in use for some time.

Improved job throughput

BOS provides job stacking for rapid job-to-job transition.

It allows you to overlap input/output operations with processing tasks.

And you can perform peripheral operations or special data

communications concurrently with a stacked job.

Reduced job turn around

BOS enables all language compilers, service programs, control programs, even your own applications programs, to reside on-line.

To achieve efficient communications between operator and system, BOS provides implicit instructions regarding all input/output devices, job continuation and similar processing activities.

Five languages

By providing a powerful and extensive group of high-level languages, PL/I, COBOL, FORTRAN, RPG, and Assembler, BOS enables you to use the language that best suits your particular needs.

BOS affords you the ability to segment your application programs in order that each segment can be written in the most appropriate language. All segments can then be combined by the BOS linkage editor into a single program—more flexible, more powerful.

And if you and your people are less familiar with operating systems in general, IBM's new BOS, with its ease of implementation, is the logical place to start getting more productive work from your computer installation.

Your IBM representative will be glad to show you how BOS is a *lot* of operating system—much more than basic.

SYSTEM/360—The Computer with a Future.

IBM®

WANT A CHANCE TO DISPLAY YOUR TALENTS?

THE DATA SYSTEMS DIVISION OF LITTON INDUSTRIES
IS CURRENTLY OFFERING UNIQUE OPPORTUNITIES FOR
INFORMATION AND SYSTEMS DISPLAY ENGINEERS

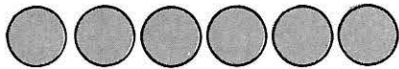

WHAT YOU'LL BE DOING

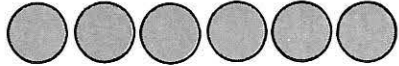

You will be involved in the design and development of advanced microelectronic display systems utilizing multiple gun CRT techniques. Your assignments will include systems design, development of overall specifications, and advanced circuitry and electronics to meet the system requirements. For these projects we need graduate engineers with experience in high resolution cathode ray techniques, storage tube display equipment, scan convertor techniques and circuitry and application of microelectronic techniques to display equipment.

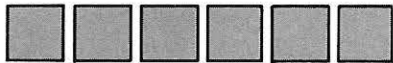

WHAT WE'VE DONE

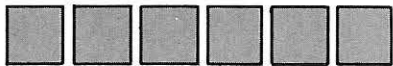

The Data Systems Division is notable for the design and development of the highly mobile MTDS (Marine Tactical Data System) and the ATDS (Navy Airborne Tactical Data System) for the E2A aircraft. We are engaged in the following systems work: air defense, air traffic control, command and control, data processing and display, reconnaissance, space information and surveillance.

WHAT WE'RE DOING NOW

LC-25, 25 Megacycle Radar Sweep Convertor

This unit accepts radar sweep data from a Radar Azimuth Convertor, symbol position data from a computer, and converts these for application to a display console. The high speed capability of the unit, utilizing primarily integrated circuits, permits display of high resolution sweeps at lower ranges than previously possible, with no switching disturbances. Current mode integrated circuits and Digital-to-Analog convertors are used.



Advanced Display Console

The Advanced Display Console is a product of Litton's continuing program to develop a line of display modules, with which displays to suit the varied applications can be constructed. Emphasis has been placed on standardization of components, reduction in weight and power, and advanced display techniques. Modules designed and constructed include Radar Azimuth Convertor, Symbol Generators, Data Entry and Readout Units, and both electromagnetic and electrostatic CRT Display Units.

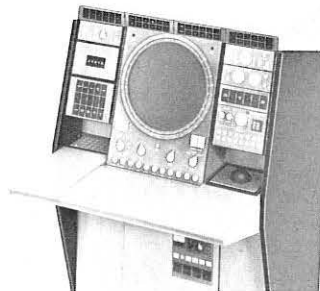

Litton's Entry Query Control Console

Designed as an interface unit for Litton's L-300 line of Microelectronic Computers, the EQCC replaces the keyboards and push-buttons usually found on Computer-control consoles. With the advantage of being programmable, it can be tailored to any type of operation or level of operator skill. It is completely self contained, with microelectron symbol generator and microelectron power supplies.

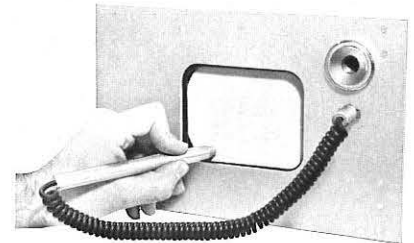

Typical of current DSD projects are these advancements:

Information Display and Systems Display Engineers are invited to apply for immediate openings. Send your resume to P. O. Box 7601, Van Nuys, California or call Mr. William Short at 781-8211, Ext. 2726.



LITTON INDUSTRIES DATA SYSTEMS DIVISION

- An Equal Opportunity Employer -



TV CAMERA DEFLECTION COMPONENTS

1" VIDICON Magnetic Deflection, Focus and Alignment Coil Data

Coil Group No.	Type Number	Horiz. Induc. mH	Yoke Res. ohms	Vert. Induc. mH	Yoke Res. ohms	Focus Res. ohms	Align Res. ohms
RECTANGULAR MOUNTING							
Single-Ended							
A1*	TV232-S500/300-F240-A283	1.0	4.0	50	175	400	150
A3	TV232-S560/500-F240-A283	.25	1.0	1.0	4	400	150
Push-Pull							
A2	TV232-P500-F240-A283	1.0	8.0	1.0	3.0	400	150
A4	TV232-P560-F240-A283	.25	2.0	.25	2.0	400	150
CYLINDRICAL MOUNTING							
Single-Ended							
B1	BV232-S620/600-F300-A283	.06	.5	.1	0.6	100	150
B3*	BV232-S500/300-F240-A283	1.0	4.0	50	175	400	150
B5	BV232-S410/300-F240-A283	8.0	27	50	175	400	150
B7	BV232-S440/340-F300-A341	4.0	20	40	160	100	10
DIRECT DRIVE, HIGH RESOLUTION AND LINEARITY							
Single-Ended							
C1	WV129-S500/350-F300-A283	1.0	4.0	32	175	100	150
C3	WV129-S620/-F240-A283	.06	.25	.06	.25	400	150
Push-Pull							
C2	WV129-P450-F300-A283	3.0	30	3.0	30	100	150
C4	WV129-P560-F300-A283	.25	1.7	.25	1.7	100	150

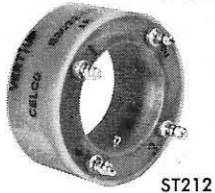
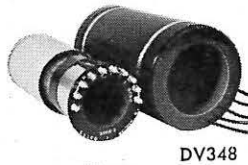
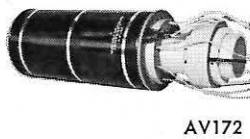
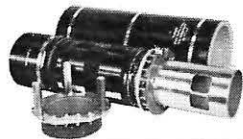
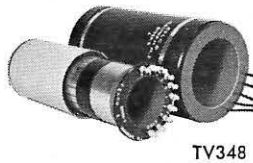
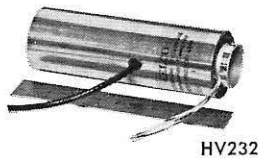
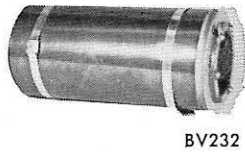
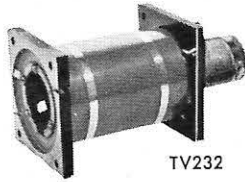

1" HYBRID VIDICON — Electrostatic Focus, Magnetic Deflection and Alignment Magnetic Shielding — Celcaloy

Coil Group No.	Type Number	Horiz. Induc. mH	Yoke Res. ohms	Vert. Induc. mH	Yoke Res. ohms	Focus Res. ohms	Align Res. ohms
Single-Ended							
D1*	HV232-S509/345-A283	.80	4	35	125	—	150
D3	HV232-S560/362-A341	.25	2.5	24	96	—	10
Push-Pull							
D2	HV232-P560-A283	.25	5.0	0.3	5.0	—	150
D4	HV232-P660-A341	.025	0.5	.03	0.5	—	10

Single-Ended 1½" VIDICON — Magnetic Deflection, Focus and Alignment

Coil Group No.	Type Number	Horiz. Induc. mH	Yoke Res. ohms	Vert. Induc. mH	Yoke Res. ohms	Focus Res. ohms	Align Res. ohms
E1	TV348-S550-F330-A280	0.3	1	0.3	1	50	160
E3*	TV348-S450/352-F215-A280	3.0	12	3.0	90	700	160

Single-Ended 1½" HYBRID VIDICON — Electrostatic Focus, Magnetic Deflection and Alignment

Coil Group No.	Type Number	Horiz. Induc. mH	Yoke Res. ohms	Vert. Induc. mH	Yoke Res. ohms	Focus Res. ohms	Align Res. ohms
K1	HV356-S550-A280	0.3	1	.3	1	—	160
K3*	HV356-S500/330-A280	1	3.5	50	185	—	160

Single-Ended 2" IMAGE ORTHICON — Magnetic Deflection, Focus and Alignment

Coil Group No.	Type Number	Horiz. Induc. mH	Yoke Res. ohms	Vert. Induc. mH	Yoke Res. ohms	Focus Res. ohms	Align Res. ohms
F1	IO448-S500/352-F215-A280	1	3.5	30	90	700	160
F3	IO448-S450/352-F330-A280	3	12	30	90	50	160

3" IMAGE ORTHICON — Magnetic Deflection, Focus and Alignment

Coil Group No.	Type Number	Horiz. Induc. mH	Yoke Res. ohms	Vert. Induc. mH	Yoke Res. ohms	Focus Res. ohms	Align Res. ohms
Single-Ended							
G1*	IO680-S480/352-F174-A314	1.4	5	30	40	1850	75
G3	IO680-S660/540-F390-A316	.025	.08	.4	.8	15	70
G5	IO680-S599/352-F360-A314	.11	.3	30	40	20	75
Push-Pull							
G2	IO680-P525/515-F360-A314	.54	1.7	.66	1.7	25	75
G4	IO680-P660/540-F390-A316	.025	.2	.4	2.	15	70

3" IMAGE ORTHICON — Direct Drive, High Resolution and Linearity

Coil Group No.	Type Number	Horiz. Induc. mH	Yoke Res. ohms	Vert. Induc. mH	Yoke Res. ohms	Focus Res. ohms	Align Res. ohms
L1	AV172-S560/500-F285-A260	.25	1	1	2.5	150	25
L2	AV172-P600-F195-A310	.10	.7	.1	.7	75	250

IMAGE DISSECTOR — Single-Ended

Coil Group No.	Type Number	Horiz. Induc. mH	Yoke Res. ohms	Vert. Induc. mH	Yoke Res. ohms	Focus Res. ohms	Align Res. ohms
H1	DV348-S550-F330-A280	.3	1	.3	1	50	160
H3	DV348-S450/352-F215-A280	3	12	30	90	700	160

STAR TRACKER — Single-Ended

Coil Group No.	Type Number	Horiz. Induc. mH	Yoke Res. ohms	Vert. Induc. mH	Yoke Res. ohms	Focus Res. ohms	Align Res. ohms
J1	ST212-S360	25	40	25	40	—	—
J2	ST212-S450	3	5	3	5	—	—

*Standard Stock Items

A wide range of resistances and inductances are available. Special Vidicon, Dissector, Uvicon, Permachon, Plumbicon and other immersion optics tube coils on request. ½" Vidicon coils to your specifications. Space environment camera coils as for Ranger, Apollo, LEM, Tiros, Nimbus, etc.

Constantine Engineering Laboratories Company

Mahwah, N. J. 201-327-1123

Upland, Cal. 714-982-0215

You can save \$50,000 on your next CRT display system.

How? Simple. Buy Conrac CRT displays. In system quantities they cost about \$1,000 each. That's \$4,000 to \$5,000 less than the displays you were going to make yourself. If your system uses 10 units, you've saved about \$40,000 to \$50,000. On more units you save more.

Specs? We prefer to let you write them. Just contact Al Landsperger, our sales manager, care of Conrac, Glendora, California. Or call him at (213) 335-0541.

Conrac alphanumeric CRT display monitors are built to your specs. Here's one such system: CRT: 23" (long axis, rectangular) Phosphor: P4 Input: differential Deflection Amplifier: 2 μ sec. small signal rise time Amplifier Settling Time: 80 μ sec. Sensitivity: 2V P-P Video: digital Included: regulated high voltage and beam-blanking protection.

CONRAC

GLENDORA, CALIF. / A DIVISION OF
GIANNINI CONTROLS CORPORATION

Master Specialties Company

Series 10E Twist-Lite® Pushbutton Switch

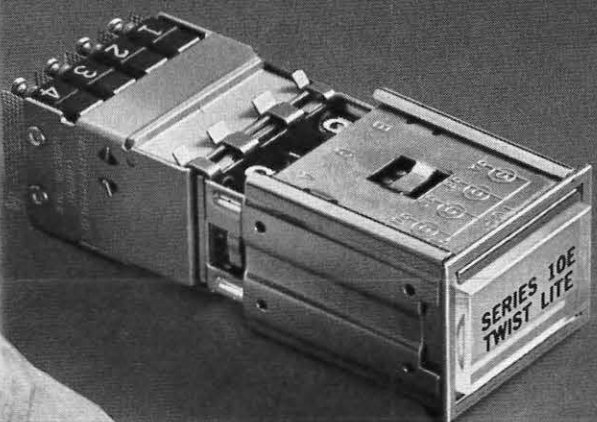

...for
rugged
duty!

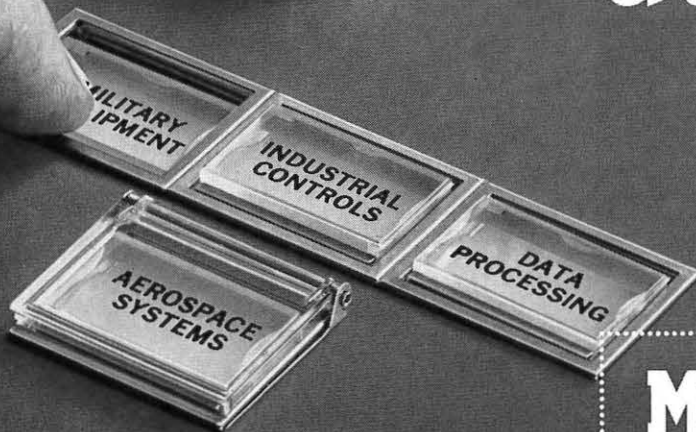

MSC



FULL SWITCHING AND INFORMATION DISPLAY CAPABILITY . . . RUGGEDIZED FOR RELIABILITY!

Mechanically, electrically and functionally engineered for rugged duty, Series 10E Twist-Lite Switches have been proven in military and aerospace applications . . . are now available for exacting industrial and commercial application.

Modular in construction, Series 10E units offer a host of standard and optional features that can be ordered under a single coded part number . . . including legends, reverse engraved to avoid wear.

Basic features include:

4-LAMP OPERATION for projected color, changeable lamp filters, display configurations ranging from full, horizontal, vertical, and three or four way split display to two color indication in full or split display.

INTERNALLY BUSSED LAMP CIRCUITS to simplify installation . . . reduce soldering operations.

SNAP-ACTION REMOVABLE SWITCH ASSEMBLIES in 2PDT or 4PDT contact arrangements, momentary or alternate action. Holding coil units for various interlock circuits are also standard.

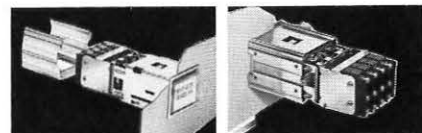

SIMPLE MOUNTING SLEEVE YIELDS A POSITIVE HARD MOUNT WITHOUT BRACKETS OR SPECIAL HARDWARE

Simply by turning captive screws in the housing, the mounting sleeve is drawn tight to a panel, providing a bearing surface along three sides of the panel cutout. Units mount in intimate contact in rows, stacks or matrices.

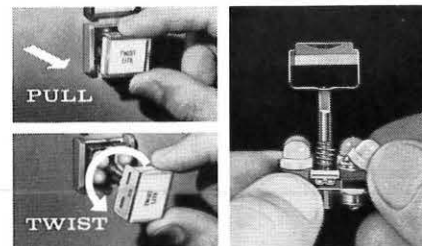

EASY TO RELAMP OR MODIFY FROM THE PANEL FRONT WITHOUT TOOLS OF ANY KIND!

A simple pull and twist removes the lamp/legend assembly from the housing to provide access to lamps, filters and legends . . . and it can be done without fear of accidental switching.

OPTIONAL FEATURES include: Switch Guard to prevent accidental switching; RFI Screens to minimize RFI passage through panel cutouts; Drip-Proof Seals to block the entrance of moisture, dust or liquids through panel cutouts, and; "Master Test" Control Capsules for lamp verification tests.

Full details are contained in
CATALOG 2000

*For specifications on Series 10H Military versions per Mil-S-22885, request Catalog 2022.

MASTER SPECIALTIES COMPANY

1640 MONROVIA, COSTA MESA, CALIFORNIA
TELEPHONE AREA CODE 714: 642-2427

REGIONAL OFFICES AND TELEPHONE

ALABAMA: Huntsville 205-536-7415
CALIFORNIA: Costa Mesa 714-642-0114
CALIFORNIA: Sunnyvale 408-245-9292
FLORIDA: Winter Park 305-647-0100
ILLINOIS: Chicago 312-282-7112
NEW YORK: Syracuse 315-479-9191
NEW YORK: Valley Stream, L.I. 516-561-2334
TEXAS: Dallas 214-357-9459



EDITORIAL

HOW MANY SYMPOSIA A YEAR?

OR

HAMLET AND INFORMATION DISPLAY (HID)

*Two shows or not two shows, that is the question
Whether 'tis better at this time to offer
One until SID members importune
For more, or two despite the attendant troubles.
Thus, by symposing on contrive to keep
Our present plans and so allow to end
The uncertainty and strife that we are prey to.*

Excuse this rather inept parody. It does express the Hamlet-like indecision that we have been contending with now that another SID National Symposium has come and gone. When we realize that in the short life (3 years) of our Society we have already had six National Symposia, we must pause and consider whether we are putting our energies to the best use. A number of questions must be answered, such as:

- Can we continue to have two symposia a year and maintain both quality in the technical sessions and interest on the part of exhibitors and attendees?
- Are symposia the best way to meet the needs of the members?
- What alternatives are possible to two full scale meetings while retaining the value of the meetings?

The list can be extended considerably and I am sure each reader has his own list of questions, and probably *answers* which is more than I can say.

To approach this problem in a moderately rational manner, let us first discuss a few of the reasons which favor the semi-annual convention. First and foremost is the geographical fact of membership distribution. Our members are almost equally divided between the East Coast from Washington to Boston, and the West Coast from San Diego to San Francisco, with a scattering at a few intermediate points. Symposia to date have shown an attendance pattern which indicated that only 20% of the attendees come from the other Coast. From this it seems logical to conclude that if the symposia were held once a year on alternate Coasts, 80% of the members would be able to attend only one symposium every two years. Is this a loss, or do the Proceedings provide sufficient coverage for the majority of the people?

The main arguments in favor of two shows are:

- The majority of members would be able to attend one of the two
- They are focal points for the formation and strengthening of chapters
- They are potential sources of income

Opposing arguments are:

- Technical content is diluted
- Exhibitor participation is more difficult to achieve
- Other activities may be more productive

Let us next examine some possible alternatives which might retain the best features of both the two-show and one-show approaches. One such alternative is to have a full blown Exhibition and Symposium once a year on alternate Coasts, but supplement it with a purely technical meeting of one day's duration on the other Coast. This arrangement would help exhibitors, reduce dilution of technical material and yet afford the majority of members the opportunity to attend one meeting each year. The purely technical symposium might be handled completely by the host chapter and eschew such frivolities as lunches, dinners, etc. thus simplifying arrange-

ments considerably. It might even be expanded to two days if the paper submission seemed to warrant it, but again without the social amenities. Alternately, we might hold several joint Chapter meetings which were expanded regular meetings but occupied ½ to 1 day's time. Various other combinations can be evolved.

The main question remains whether we want or need two major meetings of any kind each year; with a supplemental one in regard to what the format of the meetings should be. This editorial is intended to present the dilemma, and outline several possibilities and arguments pro and con in the hope that discussion and expression of opinion will result. Our next symposium is set for early 1966, but we can still make changes for the Fall, 1966 meeting in conformance with the desires of the membership.

Since you are all accustomed to circling numbers, we have provided space on the Reader Service Card to record your opinion on at least the alternatives proposed in this editorial. To recapitulate, these are:

- a) Continue two symposia per year (Circle Reader Service Card #96)
- b) Have only one symposium per year (Circle Reader Service Card #97)
- c) Have one symposium and one technical meeting (Circle Reader Service Card #98)
- d) Have no National Symposium or Meeting (Circle Reader Service Card #99)
- e) Other — specify on a separate sheet (Circle Reader Service Card #100)

Although no space is available on the card for an expression of opinion, we trust that interested readers will not hesitate to submit their thoughts and suggestions in letter form so as to provide a complete consensus. The results of this poll will appear in a later issue and will provide the basis for future planning on the part of the Board of Directors.

SOL SHERR

Northeast Regional Director
Society for Information Display

Sol Sherr is a Northeast Regional Director and Charter Member of SID. He is also National Convention Chairman and was Vice-Chairman of the 6th National Symposium. He received the Distinguished Service Award from the Mid-Atlantic Chapter in 1965 and is Chairman of the Awards Committee of that Chapter. For the last year he has been Section Head for Display Engineering at Sperry Gyroscope Co. with previous positions as Chief-Data Processing and Display at the Budd Co. and Associate Chief Engineer-Data Processing and Display at GPL Division of General Precision. He has over 23 years of experience in electronics, holds a number of patents, and has authored and presented numerous papers on various aspects of displays, information systems, and circuit theory. Mr. Sherr was born in New York City on March 23, 1918 and holds the BA and MS degrees in physics from New York University. In addition to his SID activities he is Program Chairman of the New York Section of IEEE of which he is a Senior Member, and has been chairman of the Westchester SubSection of that organization. He is also a member of Sigma Pi Sigma, the Physics Honorary Society.

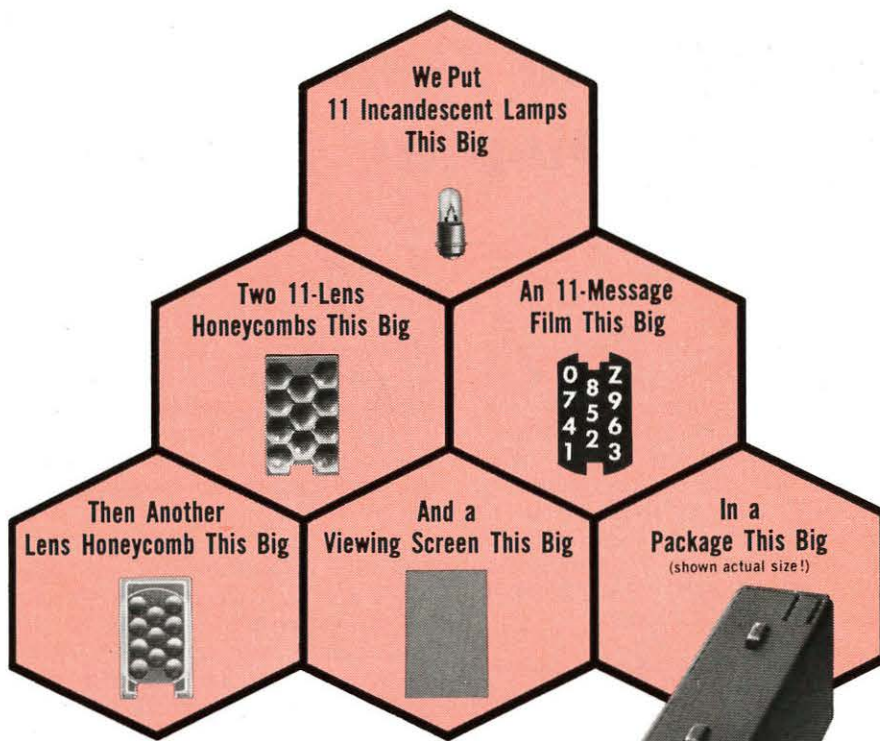

Now, You Have the Smallest Rear-Projection Readout in the World!

It Displays Characters This Big.

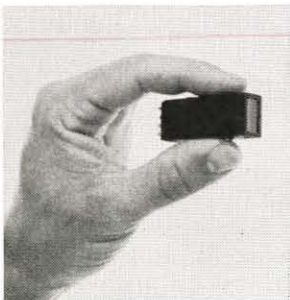

All the versatility, readability, and reliability of our patented rear-projection readouts are now available in the world's tiniest theatre: the $\frac{3}{4}$ " H x $\frac{1}{2}$ " W IEE Series 340. We've managed to fit everything but a projectionist in there to give you a choice and clarity of message that no other type of readout can match—regardless of size!

The tiny 340 uses *film* to project any message: numbers, letters, words, symbols, colors. *Anything* you can put on film! You're not limited to crudely formed characters that look strange to the eye. Choose type styles that human-factors tests prove to be most readable!

Your message appears clearly and sharply on a single-plane screen. There's no visual hash or camouflage-netting effect from unlit filaments. The 340 may be tiny, but your message appears *big*, up to an easily read $\frac{3}{8}$ " in height!

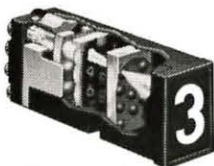

HERE'S HOW IT WORKS:

All IEE readouts are passive, nonmechanical devices built for long life. An input signal through the proper contact illuminates the desired lamp, projecting only the selected message through the lenses onto a non-glare viewing screen. This one-lamp-per-message concept eliminates character misreadings caused by partial failures.

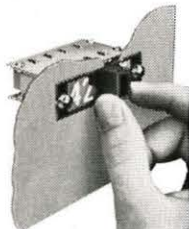

**CLICK, IT'S IN
CLICK, IT'S OUT!**

For quick, easy lamp replacement or change of message, just press the front of the 340, pull the whole unit out! Permanently wired base remains in assembly!



INDUSTRIAL ELECTRONICS ENGINEERS, INC.

7720 LEMONA AVE. • VAN NUYS, CALIFORNIA • PHONE: (213) 787-0311 • TWX (213) 781-8115
REPRESENTATIVES IN PRINCIPAL CITIES

**CALL YOUR NEAREST IEE REPRESENTATIVE
FOR A DEMONSTRATION AND
APPLICATION INFORMATION:**

- | | |
|--|---|
| ALABAMA
Huntsville
MEDCO OF MELBOURNE, INC.
Suite 90, Holiday Office Center
205-881-3721 | NEW MEXICO
Albuquerque
HYER ELECTRONICS COMPANY
1st National Bank Bldg., East
Suite 1213
Central & San Mateo N.E.
505-268-6744 |
| ARIZONA
Phoenix
GRAMER AND COMPANY
444 W. Camelback Road
602-279-1231 | NEW YORK
Baldwin
B. B. TAYLOR CORPORATION
2270 Grand Avenue
516-223-8000 |
| CALIFORNIA
Van Nuys
INDUSTRIAL ELECTRONIC
ENGINEERS, INC.
7720 Lemona Avenue
213-787-0311 | Rochester
OSSMANN COMPONENT
SALES CORP.
830 Linden Avenue
716-586-4940 |
| Palo Alto
McGILL AND MCGILL
809 San Antonio Road
415-321-0905 | Syracuse
OSSMANN COMPONENT
SALES CORP.
5958 Malloy Road East
315-454-4477 |
| San Diego
L. L. STOAKES
4438 Ingraham Street
714-274-6281 | Vestal
OSSMANN COMPONENT
SALES CORP.
Vestal Parkway East
P. O. Box 245
607-785-9947 |
| COLORADO
Denver
HYER ELECTRONICS COMPANY
E. Bellview & Valley Highway
P. O. Box 22227
303-771-5285 | NORTH CAROLINA
Bethania
THE CANDOR COMPANY
919-924-1480 |
| CONNECTICUT
Hamden
ELTRON ENGINEERING
SALES, INC.
2341 Whitney Avenue
203-288-9276 | OHIO
Cleveland
S. STERLING COMPANY
5827 Mayfield Road
216-442-8080 |
| FLORIDA
Indialantic
MEDCO OF MELBOURNE, INC.
#4 Wavecrest Drive
305-723-6924 | Dayton
S. STERLING COMPANY
3300 S. Dixie Drive
513-293-7573 |
| ILLINOIS
Chicago
MAGNUSON ASSOCIATES
5639 W. Fullerton Avenue
312-622-6322 | OREGON
RAY JOHNSTON CO.
1011 N.E. 69th St.
Seattle, Washington
(206) LA 4-5170 |
| KANSAS
Leawood
POLY-ONICS, INC.
4434 West 90th Terrace
913-648-4173 | PENNSYLVANIA
Millersville
BIECHLER ASSOCIATES, INC.
P. O. Box 38
717-872-2793 |
| MARYLAND
Ashton
BIECHLER ASSOCIATES, INC.
17733 New Hampshire Ave.
301-924-4507 | Pittsburgh
RUSSELL F. CLARK COMPANY
10517 Lindberg Avenue
412-242-9500 |
| Baltimore
BIECHLER ASSOCIATES, INC.
7353 Yorktowne Drive
301-825-8222 | TEXAS
Dallas
NORVELL ASSOCIATES, INC.
P. O. Box 20279
214-357-6451 |
| MASSACHUSETTS
Newtonville
ELTRON ENGINEERING
SALES, INC.
246 Walnut Street
617-332-6975 | Houston
NORVELL ASSOCIATES, INC.
112 Meyerland Plaza
713-665-0558 |
| MICHIGAN
Southfield
S. STERLING COMPANY
21250 10 $\frac{1}{2}$ Mile Road
313-442-5656 | WASHINGTON
Seattle
RAY JOHNSTON CO.
1011 N.E. 69th St.
(206) LA 4-5170 |
| MINNESOTA
St. Paul
MAGNUSON ASSOCIATES
1246 West 7th Street
612-227-8495 | CANADA
Ottawa, Ontario
WHITTAKER ELECTRONICS LTD.
42 Howden Avenue
613-722-7658 |
| MISSOURI
Hazelwood
POLY-ONICS, INC.
47 Village Square
Shopping Center
314-837-0597 | Roxboro, Quebec
WHITTAKER ELECTRONICS LTD.
P. O. Box 216
514-684-3000 |
| NEVADA
Las Vegas
SYSTEMS DESIGN
CORPORATION
900-1 West Bonanza
702-382-3037 | Weston, Ontario
WHITTAKER ELECTRONICS LTD.
1885 Wilson Avenue
416-247-7454 |
| | New Westminster,
British Columbia
WHITTAKER ELECTRONICS LTD.
324 Decaire St.
604-936-2244 |

Methodology for the Definition Of a Space Vehicle Display System

by Neil J. Arntz

Abstract

A methodology is presented for a systems approach to the definition of a display system for space vehicles. The mission objectives and the role of the man in the mission are used as the basis for examining display requirements.

A screening activity is used to identify and categorize all parameters to be displayed in terms of why the parameter is needed and to establish the characteristics of the parameters in each of these categories. The screening process results in the grouping of all parameters into three major categories. These are then divided into additional subcategories by considering parameter "use." The characteristics of the parameters are examined to match similar parameters to alternate methods of display.

Three functional alternates for displaying parameters are identified: individual, time-shared, and integrated. These are developed and their characteristics are identified. Each of the categories of parameters is, with the use of a "best-fit matrix," traded against these three alternates to determine which best fits the display needs of that category.

The characteristics of the parameters of each category are also used as constraints for the design-approach trade study. The activity of displaying information to the crew is given consideration in the design-approach trade in three steps: parameter accessing, parameter processing, and parameter presentation. The design-approach trade is conducted on a system-effectiveness basis by generating parametric data with weight, volume, cost, etc., used as trade considerations.

A centerline design approach is selected and defined on a display system basis. The results provide a basis for the equipment configuration definition.

1. Introduction

Current manned space flights have the primary objective of developing techniques for using man's managerial and technical capabilities in space. Each flight carries a set of experiments and it is the primary function of the flight crew to conduct these experiments. But the crews must also perform secondary functions while in space, including house-

keeping, life support, and activities related to the experiments. If these tasks are to be performed properly, the flight crew must have information displayed for their use. Such information has been termed "vehicle crew information." The purpose of this paper is to present a method for determining *what* vehicle information the flight crew needs and for determining *how* best to display this information. The method is the product of in-house studies at Boeing.

Because the crew's secondary functions use up valuable time that could be used for the experiments, the crew must be able to perform their secondary duties efficiently. To achieve such efficiency, the crew should be given only information they need, presented in a form suitable for use. In fulfilling that objective, the *what* and *how* are considered in terms of the purpose of the mission and the flight crew's role in it.

2. Approach

The method presented here comprises four major steps: requirements, screening, functional-alternate trade, and design-approach trade. The relationships and breakdown of these steps are shown in Figure 1. The section numbers at the bottom of the chart indicate the sections of this paper in which portions of the flow are discussed.

Requirements. Vehicle-crew-information requirements are obtained from three sources: system engineering, subsystem design, and customer documentation. System engineering identifies specific concepts for employing man in space; subsystem design identifies the characteristics of individual subsystems; and customer documentation identifies overall mission objectives and man's role in the mission.

Screening. Although the requirements define the total problem adequately, they do not lend themselves to direct study in the form in which they are obtained. For this reason, some means is needed for segregating the system-level requirements from those of secondary levels and human engineering. A screening process is used to identify requirements more clearly and to identify measurements that function as parameters in the total display system.

In determining these parameters, some are found to be of no use and are rejected. Others are grouped into three major categories in terms of why the

parameter is needed and on the basis of its characteristics. The three parameter categories are: crew safety, vehicle operation, and vehicle status. These categories are, in turn, broken down into seven subcategories. Each parameter falls into one or more of the subcategories according to its use.

Functional-Alternate Trade. In the functional alternate trade, methods of displaying each category are examined by considering the characteristics of the parameters making up the category. Three alternates for parameter display are considered: individual, time-shared, and integrated. A "best-fit" matrix is used in relating the seven parameter subcategories to the best display alternate.

Design-Approach Trade. Information display is considered in the design-approach trade in three steps: accessing, formatting, and presentation. Parameter characteristics are constraints in the design-approach trade, which is conducted on a system-effectiveness basis, using weight, volume, and cost, among others, as considerations.

A baseline display-system concept is the end product of the method presented here. The configuration design step in Figure 1 is not of concern here and is included only to show its relationship to the method.

3. Requirements

Display requirements assumed for this discussion are listed below. Detailed subsystem requirements are obtained from subsystem designers. Figure 2 shows a sample subsystem requirement list.

VII Symposium Society for Information Display

The Seventh National Symposium, SID, will be held October 13-15, 1966, in Boston. A National Convention Committee is being organized by the newly-formed Boston Chapter (See ID Readout, this issue of Information Display for details).

Persons in the New England area who wish to participate in planning of the Symposium and/or to affiliate with the New England Chapter, as well as others who wish to make inquiry concerning the Symposium, should contact: Harry H. Poole, Secretary, New England Chapter, Society for Information Display, 38 Claudette Circle, Framingham, Mass.

- (1) A requirement exists to display the status and provide control over the operation of a space vehicle.
- (2) The crew will be the primary controllers of the mission, assisted and advised by ground-based personnel. Major revision of the mission or rescheduling of tasks will be controlled and approved from the ground.
- (3) Parameters instrumented for multipurpose use will use common equipment as much as possible.

- (4) Data will be displayed only if it is useful, or required for:
 - Decisions relating to mission accomplishment (for example, abort, initiate repair, change mission profile, and status of expendables);
 - Observing the results of a control action;
 - Maintenance or troubleshooting;
 - Crew safety (to inform the crew of a life hazard or a condition that could lead to a life hazard);
- (5) Information displayed must be

- pertinent to overall mission success.
- (6) The display system will provide audible and visible signals to warn the crew of life hazards.
- (7) A maintenance capability will be provided.
- (8) Maintenance and checkout data will be provided to the crew.

4. Screening

The screening process is accomplished in three stages:

- (1) Parameters are listed and their characteristics are identified and reviewed in light of system-level requirements.

FIGURE 1: Study flow diagram.

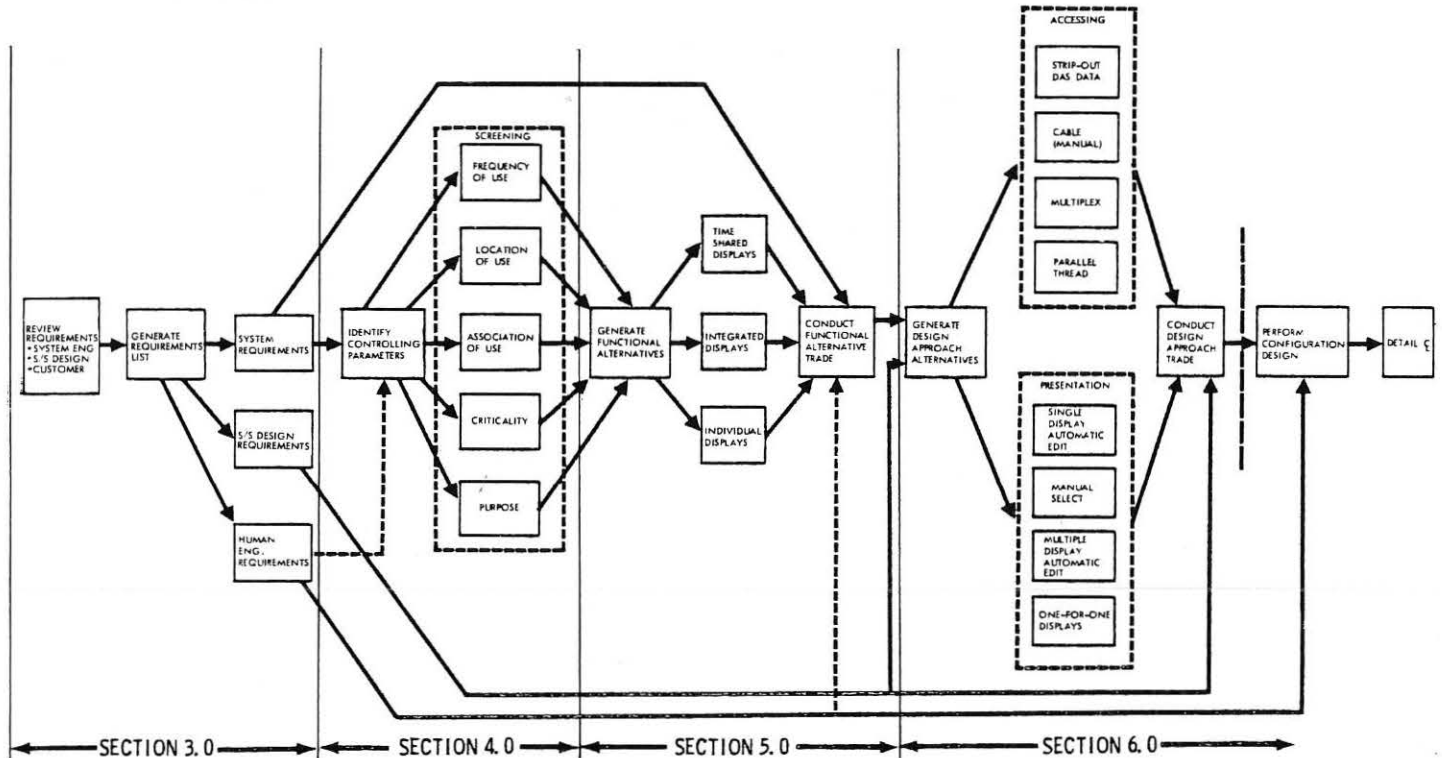

FIGURE 3: Screening worksheet.

PARAMETERS	SCREENING WORKSHEET														SUBSYSTEM		REMARKS	CATEGORY		
	LOCATION OF USE		ASSOCIATION OF USE		CRITICALITY		PURPOSE		CHARACTERISTICS		ACTUAL VALUE		REMARKS							
	LIVING AREA	WORKING AREA	SUBSYSTEM	EXPERIMENT	START OF MISSION	DURING MISSION	COMPLETION OF MISSION	IMMEDIATE EFFECT ON CREW SURVIVAL	IMMEDIATE EFFECT ON MISSION OBJECTIVES	CREW SURVIVAL	MISSION MANAGEMENT	ACCURACY		TREND	FREQ. RESPONSE	AVAIL. RESPONSE			IDENTIFICATION	GOOD/LOAD
Main Bus "A" Voltage and Main Bus "B" Voltage	X		All	X	X		X	X										2/Day, also for emergencies and as required to manage power	Qualitative indication tells crew to check that corrective measures have automatically been taken. Use for trouble shooting (e.g., bus isolation procedures). Manually override to other bus or to emergency battery, if necessary. Perform main.	4, 6 & 7
Main Bus "A" Current and Main Bus "B" Current	X			X	X			X										2/Day, same as above.	Crew uses for load management function. Same as above.	4, 6 & 7
Essential Bus "A" Voltage and "B" Voltage	X			X	X		X	X		X	X							2/Day, same as above.	Some action as main, DC bus voltage, although there is less chance override to emergency batteries is necessary. Inaction may result in loss of subsystems on particular bus.	4, 6 & 7
Fuel Cell (D) Voltage	X				X			X		X								4/Day and as needed during more than normal use of F/C.	Abnormal voltage causes crew to monitor current, purge as necessary remove from line or cut off fuel supply to F/C. Crew verifies voltage before putting on line.	6&7
Emergency Battery Voltage	X				X		X	X		X	X							4/Day and as required.	Crew should periodically test batteries, monitor current volt, and temp, and test with load Recharge and/or replan mission as necessary	6
Emergency Battery Current	X				X		X	X		X	X							As required.	Monitor battery voltage and temp, and same as above - used only when batteries are used in emergency.	6

- (2) The parameters are assigned to categories according to their use.
- (3) The characteristics of parameters in each category are identified for use in the functional-alternate and design-approach trades.

4.1 Listing of Parameters and their Characteristics

Figure 3 shows an example of a worksheet to be used in the screening process.

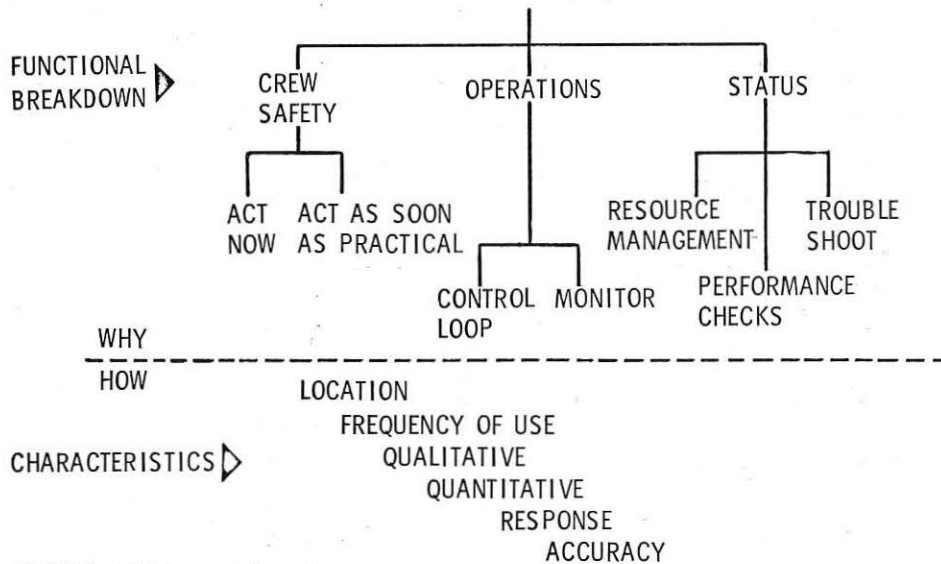

FIGURE 4: Vehicle crew information.

TABLE I: Explanation of Column Headings in Figure 3

<p>PARAMETERS — Name of measurement to be displayed, indicating where measurement is taken.</p> <p>LOCATION OF USE — Where measurement is displayed in space vehicle.</p> <p>ASSOCIATION OF USE — Information concerning:</p> <ol style="list-style-type: none"> 1) Other subsystems associated with parameter; 2) Experiments associated with parameter; 3) Mission phase in which used. <p>CRITICALITY (Entries are not required under these columns) — Includes:</p> <ol style="list-style-type: none"> 1) Immediate Effect on Crew Survival — An out-of-tolerance reading indicates an immediate or impending hazard to life; 2) Long-Term Effect on Crew Survival — An out-of-tolerance reading indicates a condition requiring correction by crew. Failure to act could result in a hazard to life; 3) Immediate Effect on Mission Objectives — An out-of-tolerance reading indicates impending mission degradation and calls for immediate change in mission plan. 4) Long-Term Effect on Mission Objectives — An out-of-tolerance reading indicates a condition requiring eventual correction. Failure to act can result in mission degradation or a need for mission replanning. <p>PURPOSE — Why measurement is needed. For example, to aid in:</p> <ol style="list-style-type: none"> 1) Crew survival; 2) Maintenance, checkout, and repair; 3) Vehicle system management and mission efficiency; 4) Performing experiments; 5) Fulfilling mission objectives. <p>CHARACTERISTICS — Includes:</p> <ol style="list-style-type: none"> 1) Overall accuracy in percent of full scale; 2) Trends in measurements; 3) Frequency content or rate of change of measurement under normal conditions; 4) Usefulness of measurement when displayed qualitatively (in or out of tolerance); 5) If actual value is needed, enter frequency of use; if used periodically, enter times of day when used. <p>REMARKS — Any information that cannot be included in work-sheet columns, and any action that must be taken to correct an out-of-tolerance condition.</p> <p>CATEGORY — Used to categorize measurements into groups for use in the functional-alternate trade.</p>
--

cess. Column headings are explained in Table 1.

4.2 Categorization of Parameters

The three categories and seven sub-categories into which parameters are segregated by the screening process are shown in Figure 4. The following paragraphs describe the categories and sub-categories in the figure.

PARAMETERS

PITCH ATTITUDE
 ROLL ATTITUDE
 YAW ATTITUDE
 PITCH RATE
 ROLL RATE
 YAW RATE
 PITCH ATTITUDE GYRO RUN
 ROLL ATTITUDE GYRO RUN
 YAW ATTITUDE GYRO RUN
 PITCH ATTITUDE GYRO TEMP.
 ROLL ATTITUDE GYRO TEMP.
 YAW ATTITUDE GYRO TEMP.
 PITCH RATE GYRO TEMP.
 MAIN BUS "A" VOLTAGE
 MAIN BUS "B" VOLTAGE
 MAIN BUS "A" CURRENT
 MAIN BUS "B" CURRENT
 ESSENTIAL BUS "A" VOLTAGE
 ESSENTIAL BUS "B" VOLTAGE
 FUEL CELL (3) VOLTAGE
 EMERGENCY BATTERY VOLTAGE
 EMERGENCY BATTERY CURRENT

FIGURE 2: Subsystem parameters proposed for display.

4.2.1 Crew Safety

Includes parameters indicating conditions hazardous to life or that can become hazardous to life.

Act Now. An immediate hazard to life exists and calls for immediate crew action. Crew response will depend on the parameter displayed.

Act as Soon as Practical. A condition exists that can become hazardous to life and some action will be required. Crew response will depend on the parameter and the seriousness of the situation.

4.2.2 Vehicle Operations

Includes parameters required to enable the crew to perform normal vehicle operations or to take over functions normally under automatic control.

Control Loop. Parameters needed to allow the crew to complete the loop in a closed-loop feedback system. Normally these will be temporary closures and the parameters will not be needed continuously.

Monitor. Parameters needed to allow the flight crew to monitor the operation, or initiate operation, of an automatic or normally closed-loop system. Crew action is not normally needed to cause the system to function properly.

4.2.3 Vehicle Status

Parameters needed to allow the crew to observe or check the status of vehicle subsystems or subsystem segments. Information is needed for activity planning and decision making.

Resource Management. Parameters providing information concerning such expendables as fuel, water, and atmosphere.

Performance Check. Parameters used in performing confidence tests and in verifying subsystem operational integrity. Information might be used before initiating a new mission phase or on a regularly scheduled basis.

Troubleshooting. Parameters used in isolating malfunctions and determining repair methods. Malfunctions normally will have been detected in a performance check or during normal operational activities.

4.3 Category Listing

A listing of the parameters in each category should be compiled, and parameter characteristics should be transferred from the screening worksheets to the category listing to point up the characteristics in each category. Duplicate entries for a given parameter will occur among categories. No attempt need be made to eliminate duplications, as they will not interfere with use of the listing. A sample category listing sheet is shown in Figure 5. Category assignments on the category listing sheet should be noted on the screening worksheet for cross reference.

4.4 Results

The following are the primary results of the screening process.

- (1) Parameters not required for vehicle-crew-information display are eliminated.
- (2) Required parameters are identified and categorized according to use.
- (3) Parameter characteristics are identified.

FIGURE 5: Operations monitor (4).

PARAMETER	QUALITATIVE	ACCURACY	QUANTITATIVE		FREQUENCY OF USE	FREQUENCY CHARACTERISTICS	LOCATION	
			RANGE	TREND				
Tape Footage #1	-	+5%	2300 ft	-	16/day	-	Working Area	
Tape Footage #2	-	+5%	2300 ft	-	16/day	-	Working Area	
Tape Footage #3	-	+5%	2300 ft	-	8/day	-	Working Area	
Tape Footage Wide Band	-	+5%	1200 ft	-	8/day	-	Working Area	
Status Rec. #1	Mode	-	-	-	12/day	-	Working Area	
Status Rec. #2	Mode	-	-	-	12/day	-	Working Area	
Status Rec. #3	Mode	-	-	-	6/day	-	Working Area	
Status Wideband	Mode	-	-	-	6/day	-	Working Area	
Time to next Xmission	X	+1sec	5 hrs	-	16/day	1/sec	Working Area	
Time	-	+1sec	24 hrs	-	30/day	1/sec	Working area	
Physical Conditioner-					Twice/day			
Auditory Pacer	X	+10%	Fixed			1/sec	Living Area	
Main Bus A Voltage	X	+1%	0-50 vdc	-	2/day	1/sec	Working Area	See also 6 & 7
Main Bus B Voltage	X	1%	0-50 vdc	-	2/day	1/sec	Working Area	See also 6 & 7
Main Bus A Current	-	3%	0-300 A	-	3/day	1/sec	Working Area	See also 6 & 7
Main Bus B Current	-	3%	0-300 A	-	2/day	1/sec	Working Area	See also 6 & 7
Essential Bus A Voltage	X	1%	0-50 vdc	-	2/day	1/sec	Working Area	See also 6 & 7
Essential Bus B Voltage	X	1%	0-50 vdc	-	2/day	1/sec	Working Area	See also 6 & 7
Living Area Pressure		+5%	0-7 psia		5/day	1/10 sec	LA	See also 1 & 2
Working Area Pressure		+5%	0-7 psia		5/day	1/10 sec	LA	See also 1 & 2
LA O ₂ Part Press		+5%	0-5 psia		5/day	1/10 sec	LA	See also 1 & 2
WA O ₂ Part Press		+5%	0-5 psia		5/day	1/10 sec	WA	See also 1 & 2
LA Temp		+5%	0-150°F		5/day	1/5 min	LA	
WA Temp		+5%	0-150°F		5/day	1/5 min	WA	

QUAL. QUANT.

	CREW SAFETY		VEHICLE OPERATIONS		VEHICLE STATUS		
	1	2	3	4	5	6	7
ENVIRONMENTAL CONTROL SYSTEM	4	11		3 7	6 5	34 15	2 24
LIFE SUPPORT	7	7		1		13	
COMMUNICATIONS			2			3	11 22
ELECTRICAL POWER SYSTEM		1		4 6		16 17	10 12
ATTITUDE CONTROL SYSTEM	4	8	7		4	26 6	
DATA ACQUISITION SYSTEM (TELEMETRY)				5 6			6
TOTAL	15	27	9	13 19	6 9	76 54	23 64

FIGURE 6: Screening results.

The outputs of the screening process – categorization of parameters and identification of parameter characteristics – become inputs to the functional-alternate and design-approach trades. The suitability of possible functional alternates can be assessed and parameters of various distinct types can be counted to determine effective display systems.

Figure 6 shows a representative set of parameters segregated by category in a screening process. The three categories are shown with a breakdown into the seven subcategories. The numbers in the column headings refer to the numbers in subcategory blocks of Figure 4.

5. Functional-Alternate Trade

Previous sections have dealt with the question: what should be displayed? Attention is now directed to the question: how should it be displayed?

Three functional alternates for accommodating information display requirements have been identified: individual, time-shared, and integrated. The following discussion develops these alternates, identifies their characteristics and matches the seven categories with their "best-fit" alternate.

5.1 Functional-Alternate Development

The information-display process comprises the following functional activities.



The functional implementation of these activities for each alternate considered is developed in the following discussions.

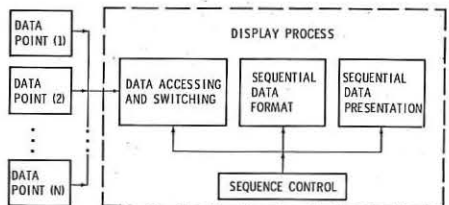

FIGURE 7: Time-shared.

5.1.1 Time-Shared Displays

The time-shared-display concept accesses, formats, and presents information through the use of common elements by sequentially operating on data. The functional implementation of time-shared displays is shown in Figure 7.

5.1.2 Individual Displays

The individual-display concept accesses, formats, and presents data with a one-for-one correspondence between data points and display elements. The functional implementation of the individual display is shown in Figure 8.

5.1.3 Integrated Displays

The integrated-display concept accesses two or more data points, performs some logical formatting on this data, and presents the results of the formatting through a common instrument. In most instances, the resulting data serves some use more effectively than the primary data. An example that may clarify this notion is the "8-ball" of the attitude-control system, where the roll, yaw, and pitch angles are presented through angular displacement of a sphere against vehicle reference. The functional implementation of the integrated display is shown in Figure 9.

5.2 Identification of Functional-Alternate Characteristics

The three functional alternates – time-shared, individual, and integrated – have certain characteristics imparted by the functions of data accessing, data formatting, and data presentation. These characteristics are identified below.

5.2.1 Time-Shared Displays

Time-shared display access data points and sequentially connect them to the formatting and presentation elements. In general, any increase or decrease in the number of data points will manifest itself in the form of configuration changes only for the accessing element. Because

Normalized

- Power
- Weight
- Volume
- Cost
- Panel Area

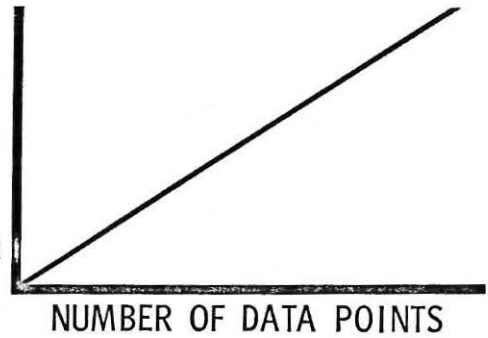

FIGURE 13

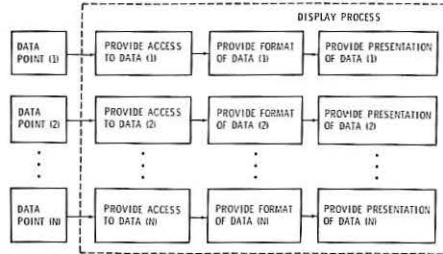
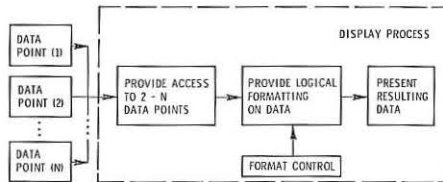

FIGURE 8: Individual.

FIGURE 9: Integrated.



the formatting and data presentation elements process data points sequentially, their configurations are immune to change as a result of changes in number of data points. The effects of additions or deletions of data points on display system physical characteristics shown in Figure 10. The influence of having configuration

FIGURE 10

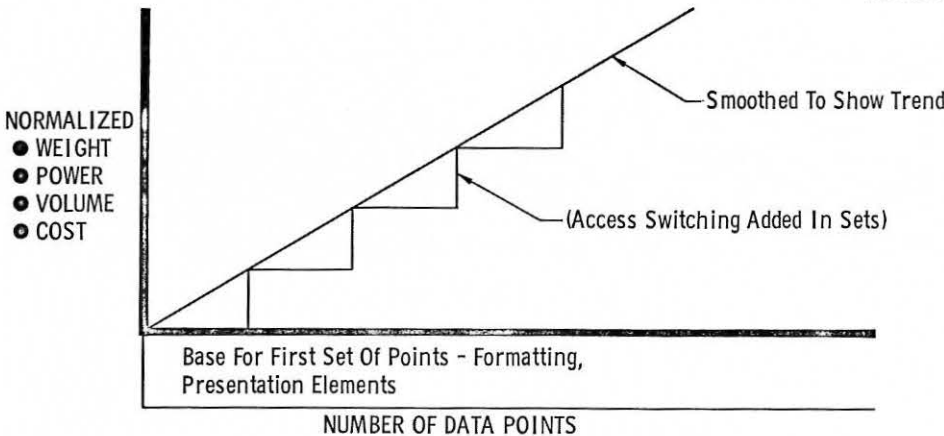

FIGURE 11

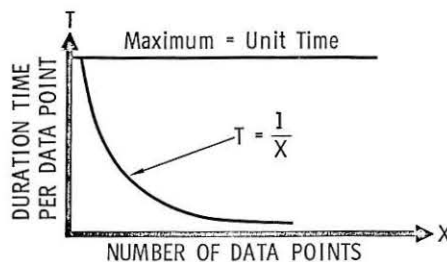
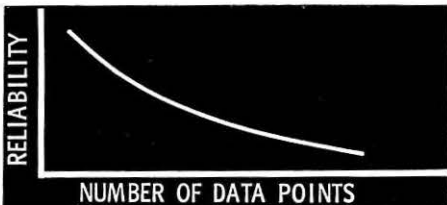

FIGURE 12

changes apply only to data accessing is evident.

Although the ability to add data points with resulting changes in physical characteristics restricted to the accessing element is a distinct advantage, it is not obtained without some loss. As discussed below, reliability and time available to individual data points are adversely affected by the addition of data points.

Two distinct measures of display-system reliability must be considered: (1) success-path reliability for a single data point, and (2) success-path reliability for all data points in the system. The second measure does not lend itself to functional analysis because of its strong dependence on hardware design. The first measure can be defined as the probability of successfully displaying one particular data point from a group of data points.

Because configuration changes to accommodate data-point additions are restricted to the accessing element, complexity of the formatting and presentation elements is not a function of the number of data points. Rather, only usage time is a function of total data points for these elements. For the accessing element, both complexity and usage time are functions of the number of data points. The following four effects on the probability of successfully displaying a given data point are, therefore, a function of total data points:

- (1) T_1 , effect of formatting-element use time;
- (2) T_2 , effect of presentation-element use time;
- (3) T_3 , effect of accessing-element use time;
- (4) λ_3 , effect of increase in accessing-element complexity.

The total effect is approximately equal to $e^{-AT_1} \cdot e^{-BT_2} \cdot e^{-\lambda_3 T_3}$ (where A and B are constant failure rates) and is given by the general exponential shape shown in Figure 11.

The time allotted to each data point, assuming equal allotment to all points, varies inversely with total data points, as shown in Figure 12.

FIGURE 14

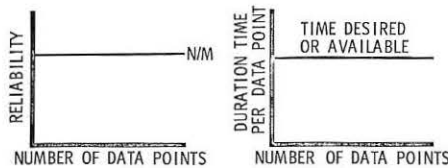

5.2.2 Individual Displays

Individual displays have a one-for-one correspondence between data points and the accessing, formatting, and presentation elements. Consequently, as shown in Figure 13, display-system physical characteristics are proportional to the total number of data points.

Unlike the time-shared display, reliability and time per data point are unaffected by total number of data points. Assuming that data points are displayed successfully N out of M times, the reliability for each data point is N/M , which is constant. Likewise, with some fixed time duration available (or desired) per display element, and with additional elements added on a one-for-one basis with each additional data point, display time is a constant, unaffected by increased numbers of data points. Their relationships are shown in Figure 14.

5.2.3 Integrated Displays

In general, integrated displays differ from individual displays only in the logical formatting element. The differences are a function of formatting complexity, as shown in Figure 15.

FIGURE 15

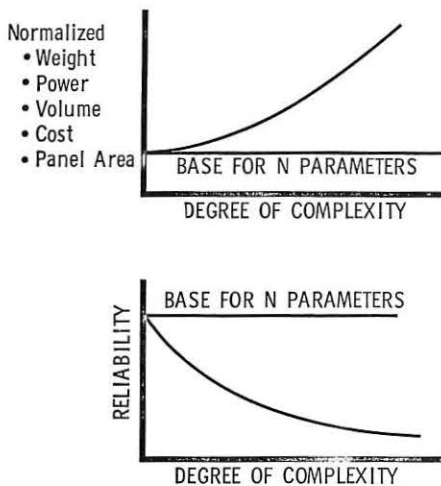

5.3 Functional Alternate/Parameter Best-Fit

Having defined the functional alternates and described their characteristics, it is now possible to determine, systematically, which functional alternate or alternates should be used for the display parameters in each of the seven screening categories.

To do this, a three-dimensional matrix is constructed. The first dimension contains the seven screening categories, the

TABLE II: Sample Best-Fit Matrix

Crew Safety — Act Now (1)

ASPECTS	TIME-SHARED	INDIVIDUAL
Need for continuity	Adequate if servicing frequency is such that delay in having the information presented does not affect crew survival.	Excellent. Would give full-time continuous display of information.
Need for trend data	NOT APPLICABLE Trend information not required. Only out-of-tolerance conditions displayed.	
Frequency of usage	Information required continuously; necessitates frequent servicing of these parameters.	Excellent. All parameters are serviced continuously.
Reliability	IMPORTANT CONSIDERATIONS FOR THESE PARAMETERS This alternate may be adequate, but reliability is inversely related to number of parameters serviced.	
Frequency Response	Adequate. Can be accommodated.	Adequate. Inherent to alternate.
Association of Use	NOT APPLICABLE No time available to associate malfunction with other displays. Immediate action required.	
Convenience of Use	NO SIGNIFICANT DIFFERENCE These parameters are displayed continuously.	
Adaptability	Adequate if the sequencing rate is commensurate with man's ability to take action. Consideration should be given to an integrated display.	Good. Consideration should be given to an integrated display.
Flexibility and Growth	Good. In most cases would require changes in manner of accessing.	Fair. Requires changes in formatting and presentation elements, as well as accessing.
NO CHANGES IN THESE PARAMETERS ARE ANTICIPATED		

second dimension, the functional alternates, and the third dimension is made up of nine aspects. Each aspect is identified by a word or two that represents a viewpoint pertaining to the suitability of a functional alternate with respect to the display needs of a category of parameters.

The matrix is then used in segments. A segment is composed of a screening category, the functional alternates, and the nine aspects. Each aspect is applied to each of the functional alternates. Evaluation of the viewpoint involved with respect to each alternate results in judgments that will dictate which functional alternate is most suitable to the screening category. This is done for each of the nine aspects.

Further evaluation, with primary considerations being functional-alternate characteristics and category parameter requirements, is then performed. This evaluation results in the choice of a functional alternate that is the best-fit for the particular screening category. This is done for each of the seven categories.

As identified in Section 5.2.3, the integrated displays have the same characteristics as the individual displays. Hence, only two columns are needed in the trade matrix. Comments are made when the integrated display alternate might be used.

5.3.1 Best-Fit Matrices

The comments in the seven best-fit matrices, an example of which is shown in Table 2, are the judgments resulting from the evaluation discussed above. Following are explanations of the nine aspects.

Need for Continuity. How well does the display alternate satisfy the needs of continuously presenting data concerning this parameter category?

Need for Trend Data. Is quantitative time-history data required for parameters of this category and how well is the requirement satisfied by the display alternate?

Frequency of Usage. How often are the parameters in this category used and how well does the display alternate satisfy the need?

Reliability. What is the value of a high degree of reliability in presenting data and how well does the display alternate satisfy reliability requirements?

Frequency Response. How well can the frequency-content or rate-of-change requirements of parameters of this category be accommodated by the display alternate?

Association of Use. What effect does using this alternate have with respect to associated information in presenting this category of parameters?



Buy D1G1TUBES™ now, or pay later!

**BAIRD-ATOMIC D1G1TUBE™ DISPLAY TUBES GIVE YOU
CLEAR, RUGGED, RELIABLE READOUT FOR HUNDREDS OF THOUSANDS OF TROUBLE-FREE HOURS!**

The inherent simplicity and ruggedness of a Baird-Atomic cold cathode neon glow D1G1TUBE assure you of perfect performance throughout its extremely long life. The bright, distinct, digital character display will not fade with age!

In fact, a D1G1TUBE will often outlast the equipment in which it is installed. So if you buy D1G1TUBES now, you won't have to pay later in replacements, in



downtime at the wrong time, or in the immeasurable cost of mistakes in readout interpretation.

A wide range of character sizes is available in round or rectangular shape tubes. Write to Baird-Atomic Electronic Products Division for the new brochure on D1G1TUBES detailing the electrical ratings, operating characteristics, circuits, and applications of these dependable display tubes.

Scientists: Investigate challenging opportunities with Baird-Atomic. An Equal Opportunity Employer.



ELECTRONIC PRODUCTS AND COMPONENTS DIVISION

33 UNIVERSITY ROAD, CAMBRIDGE, MASSACHUSETTS 02138, Telephone: 617 864-7420

OFFICES: ATLANTA BOSTON CHICAGO DALLAS DETROIT LOS ANGELES NEW YORK PHILADELPHIA PITTSBURGH SAN FRANCISCO WASHINGTON, D.C.
EUROPE: BAIRD-ATOMIC (EUROPE) N.V., 26-27 VEENKADE, THE HAGUE, HOLLAND

TABLE III: Best-Fit Matrix

CATEGORY	TIME-SHARED	INDIVIDUAL	INTEGRATED
CREW SAFETY — ACT NOW	Adequate	(GOOD)	GOOD*
CREW SAFETY — ACT AS SOON AS PRACTICAL	Adequate	(GOOD)	GOOD*
OPERATIONS — CONTROL LOOP	Adequate	(GOOD)	GOOD*
OPERATIONS — MONITOR	(Good)	MORE THAN ADEQUATE	N/A
STATUS — RESOURCE MANAGEMENT	(Good)	ADEQUATE	N/A
STATUS — PERFORMANCE CHECK	(Good)	ADEQUATE	N/A
STATUS — TROUBLE SHOOTING	(Good)	POOR	N/A

(CHOICE) * CHOICE FOR SELECTED PARAMETERS

Convenience of Use. Does this alternate lend itself to quick and easy assimilation of the display information and does it require minimum effort to use?

Adaptability. How well does the display alternate lend itself to implementation for this category of parameters?

Flexibility and Growth. How well does this display alternate exhibit flexibility to changes on a flight-to-flight basis and adapt to growth on a total-program basis for this category of parameters?

5.3.2 Selection of the Best-Fit Alternate

This section selects the best-fit functional alternate for each category of parameters. This is done by "weighing" the advantages against the disadvantages of each alternate for each parameter category. These were identified in the foregoing matrices and the functional-alternate-characteristics development. Table 3 indicates the alternate chosen for each parameter category. The reasons for each choice are given below.

Crew Safety — Act Now (1). The individual or integrated display alternate has the significant advantage of superior reliability, which for these parameters far outweighs the advantages of flexibility and growth, power, cost, etc., common to the time-shared alternate.

Crew Safety — Act as Soon as Practical (2). This category lends itself well to individual or integrated displays for every aspect with the exception of flexibility and growth. The aspects of need for trend data, frequency of usage, and association of use are better handled by individual or integrated displays because

of simultaneous and continuous accessing, formatting, and presentation requirements. This and the consideration of reliability offset the advantages of the time-shared alternate.

Operations — Control Loop (3). The individual or integrated display alternate is better suited for this category because of the advantages gained from the aspects of need for continuity, need for trend data, association of use, and convenience of use. For particular parameters within this category, the convenience-of-use and association-of-use aspects indicate that strong consideration should be given to combining them into an integrated display.

Operations — Monitor (4). The time-shared alternate is suitable for this category of parameters and is selected because of the advantages of less cost, power, weight, etc.

Status — Resource Management (5). Either the time-shared or individual alternate is suitable for this category of parameters, but the time-shared alternate is chosen because of the advantage of less cost, power, weight, etc.

Status—Performance Check (6). Time-shared displays serve this category best because they are more convenient to use and are more adaptable. There are no factors which prohibit taking advantage of this display method.

FIGURE 16: VIS strip-out accessing.

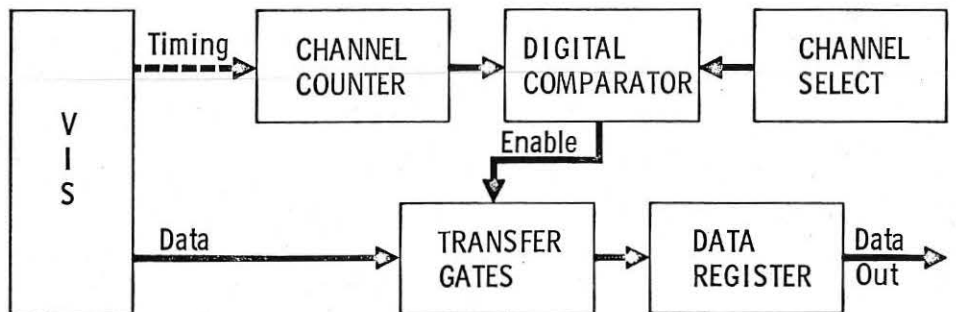
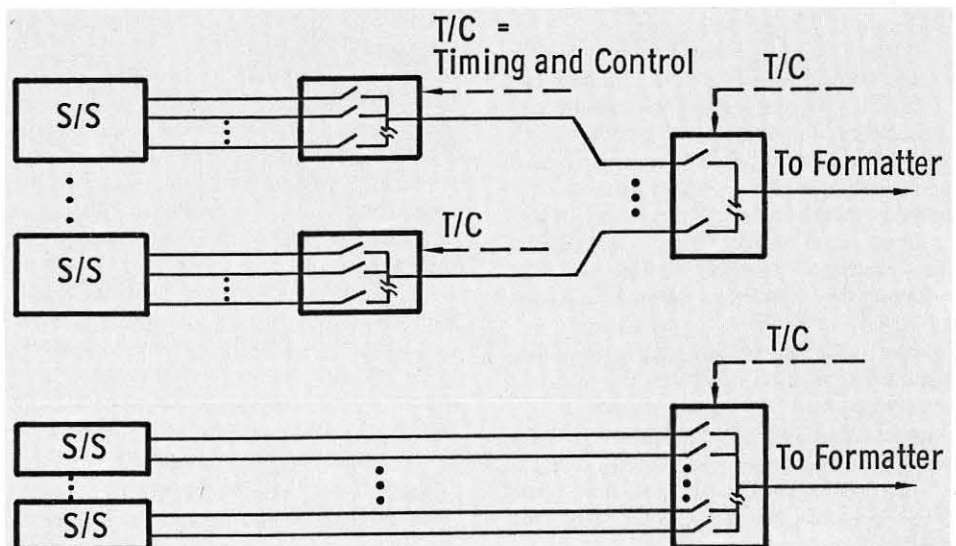

FIGURE 17



Status — Troubleshooting (7). The time-shared alternate is best suited for this category of parameters for the same reasons as those given for status — performance check.

Exceptions. Same parameters will be exceptions to these category/alternate best-fit combinations and should be given special consideration.

6. Design-Approach Trade

The screening activity was used to categorize the parameters needed for vehicle crew information into seven functional groups. The functional-alternate trade was used to match these groups to an alternate giving the best fit by examining the characteristics of the parameters. This section trades several design approaches developed from the functional alternates.

In the following discussion, design data is developed, four classes of design approaches are identified and traded on a parametric basis, and a centerline is selected.

6.1 Design Data Development

As discussed in Section 5.1, the display process has three functional activities: accessing, formatting, and presentation. The following discussion develops design data for each of these functions for use in the design-approach trade.

6.1.1 Accessing

Four distinct methods for accessing parameters were identified. These are presented in the following paragraphs.

Data Acquisition Subsystem Stripout. The data acquisition subsystem (DAS) collects and formats data for transmission to the ground stations, and much of this same data is needed for display aboard the space vehicle. Hence, by "stripping" this data out of the DAS, it can be made available for flight-crew display. The interface and selection logic for accessing this data from the DAS is shown in Figure 16.

Controlled Switching. The vehicle subsystems are physically distributed throughout the space vehicle. Data can be accessed on a sequential basis through controlled switches that sequentially connect each of many inputs to a single output (multiplexer). Several multiplexer units can be distributed throughout the vehicle or a single switch unit can be centrally located. Figure 17 shows the two methods.

Hard Line. In this method, data points are hard-wired-connected for the formatting element as shown in Figure 18.

Manually Connected Cable. In this method, a single multiwire cable is manually connected to standard connector plugs provided on the subsystems. This method is shown in Figure 19.

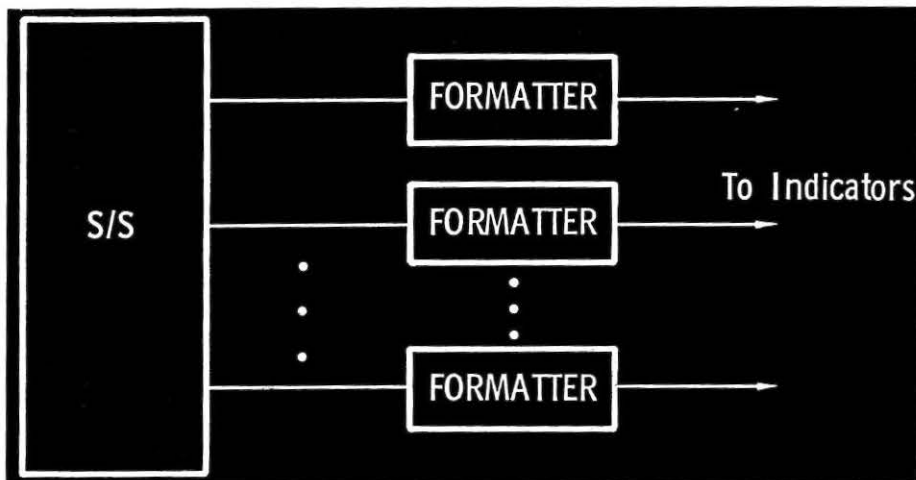
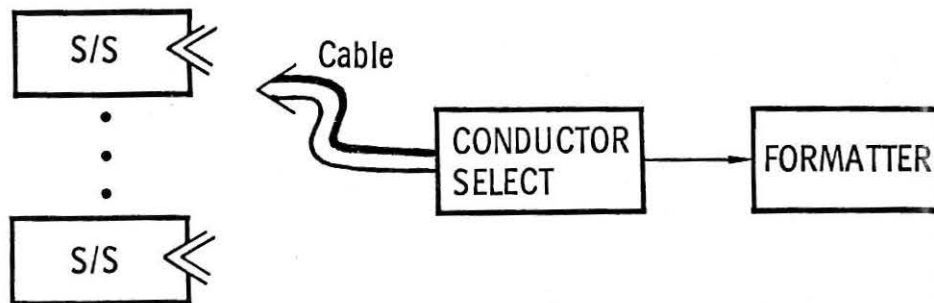

FIGURE 18

FIGURE 19: Manually connected cable accessing.



6.1.2 Formatting Devices

Two major classes of formatting devices have been considered: electromechanical and electronic (both analog and digital).

Electromechanical. Through the history of display development, a number of electromechanical devices have been developed. These elements accept either mechanical or electrical inputs (or both) and produce a signal that when presented is more useful than any of the primary input data. Frequently, the signal produced is in itself a physical movement or indication. Hence, the formatting and presentation functions are commonly satisfied. An example is the three-axis attitude indicator (8-ball). Electrical inputs, through closed-loop servo action, cause a sphere to receive a physical angular displacement with respect to vehicle reference. Hence, the formatting and presentation processes become one. This formatting and presentation element has been developed to serve a very special class of applications. In most cases, this development process has been over a long period of time and improvements have come through experience. Since these types of elements have such a common acceptance, no attempt is made to replace or improve them.

Electronic. The flexibility achievable with today's electronics gives a capability for producing a wide variety of for-

matting- equipment, ranging from simple passive elements to complex computing systems. A number of the more common formatters that have been used are identified below.

Scaling and Buffering Amplifiers. The scaling and buffering amplifiers are used to match the range and impedance characteristics of the data points with the indicators. The amplifiers considered are solid-state integrated-circuit devices selected for the specific application.

Analog Comparator. The analog comparator considered is an operational amplifier with fixed limits that accepts an analog voltage and compares this input voltage with the limit voltages. The device has discrete output states to identify the comparison as either in or out of tolerance.

Analog-to-Digital Converter. The analog-to-digital converter is an electronic device that accepts analog voltage signals and produces a digital representation of the analog value in the form of a binary bit pattern. The analog-to-digital converter considered is a solid-state unit that employs the successive approximation technique. The converter quantizes the analog input to an 8-bit parallel or serial digital output with a conversion time of 2 milliseconds.

Fixed Digital Logic Devices. The fixed digital logic devices considered include

conventional AND gates, OR gates, flip-flops, etc. These devices are selected for specific applications.

Programmer-Evaluator. The programmer-evaluator considered in this study is a special-purpose digital processing unit with 1000-word memory. The unit has hard-wired program routines with limited arithmetic capability.

Stored Program Sequencer. The computer considered is a digital stored-program processing unit having a nominal arithmetic capability with flexibility in the input-output control. Characteristics of this computer are based on the Boeing Lunar Orbiter programmer.

6.1.3 Presentation Devices

Five categories of indicators have been considered.

Galvanometers. The galvanometer type of indicators accept an analog signal and physically deflect an indicator needle across a fixed scale as a function of the analog voltage or current amplitude.

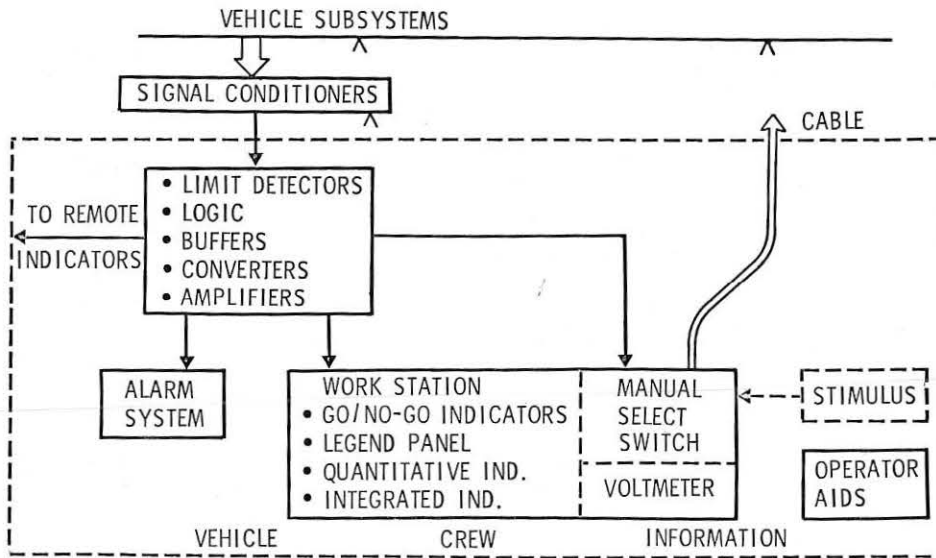

FIGURE 20: System 1.

Servo-Driven Tapes. The servo-driven tape unit accepts analog data and features a fixed pointer behind which a graduated tape is driven by a servo motor. Several tapes may be placed side by side in the same instrument to display related data. Readability and resolution are superior to dial instruments since a single-loop tape of several feet can be used. Tapes may be color-coded to indicate scale changes, critical areas, or other gross indications.

Go/No-Go and Legend Lamps. These indicators are simple incandescent or glow-discharge lamps that accept discrete voltage signals and convert them to light energy. The lamps are covered with colored lenses with or without printing to indicate gross qualitative information. The legend lamps with printing on the lens can indicate status or action required, and may include a manual switch as an integral part.

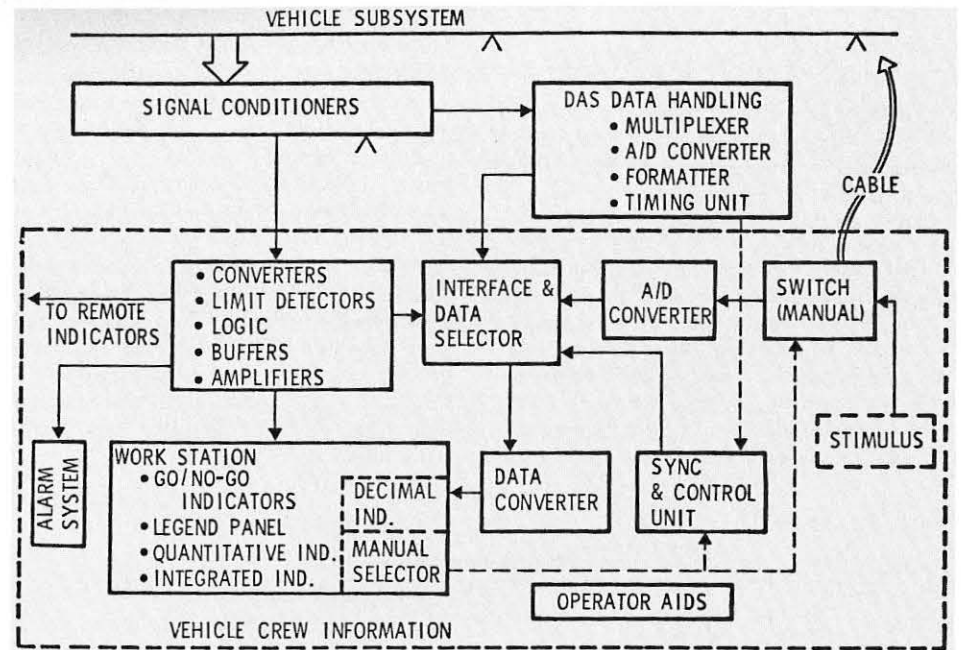

FIGURE 21: System 2.

The alternates presented earlier use conventional, proven components and techniques as building blocks to form an integrated system. The configurations considered are represented by four general system block diagrams (Figures 20 through 23) showing the different techniques by which the accessing, formatting, and presentation functions are accommodated. The approaches considered all include individual, integrated, and time-shared elements. These systems were chosen to present a wide range of types and vary from manual selection and evaluation of parameters to fully automatic accessing, editing, and evaluation.

Within the four system types many variations are possible, allowing flexibility in determining a detail baseline configuration.

All of the design approaches have common functions and equipment not subject to trade:

- (1) Signal conditioning of raw data is required in all approaches and is not considered as a variable.
- (2) Stimulus capability required for troubleshooting and operational checkout can be accommodated by all the systems and is not defined in detail in the design-approach alternates.
- (3) Parameters for crew safety are to be monitored continuously with an automatic alarm system. A high-reliability monitor method using analog limit detectors and go/no-go indicator panels and alarms is included in each alternate.
- (4) Certain integrated displays developed specifically for a unique job are the most effective way of presenting some forms of data. These displays, such as vehicle attitude and orbital position, are common to all systems and are not subject to trade.

6.2 Description of Design-Approach Alternate

Several alternates were selected from the many possible configurations as the best representative approaches based on the requirements and the considerations presented in previous sections of this report. No attempt has been made to advance display-systems technology or to propose radically new or unique uses of existing elements.

6.2.1 System 1

This system, shown in Figure 20, consists of integrated, individual, and time-shared elements. Data is evaluated manually by the crew, except for the critical safety parameters.

Parameters associated with crew safety are automatically evaluated and an alarm system warns the crew when a hazardous situation exists. These signals are compared with predetermined tolerance values by analog limit detectors. Each detector drives a go/no-go indicator on the legend panel that indicates

FIGURE 22: System 3.

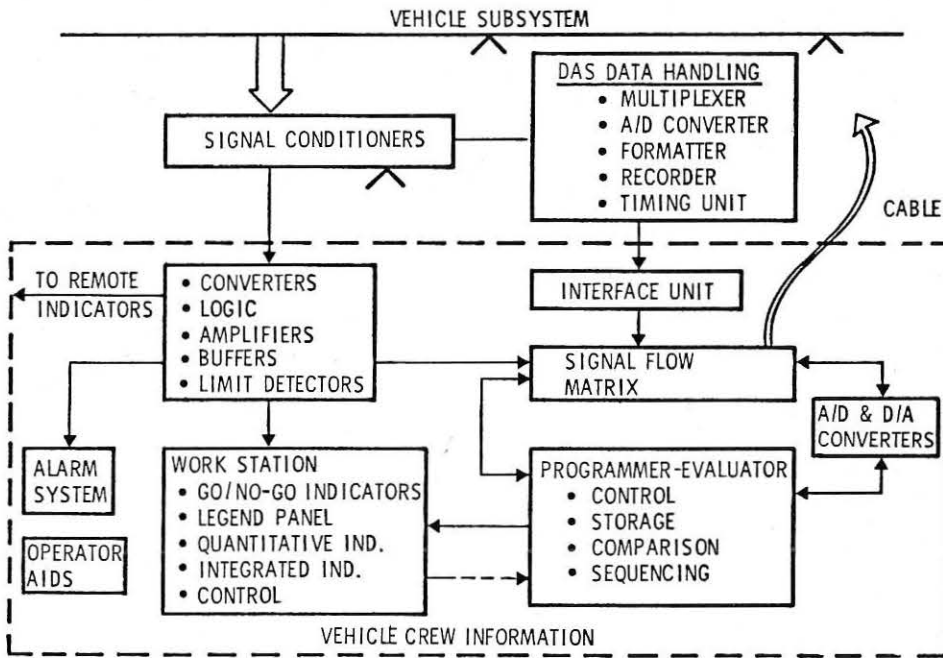

what malfunction has occurred. In addition, the outputs of the detectors are formatted by logic circuits so that a master visual-audio alarm is activated when any signal is out of tolerance.

Parameters needed frequently or that are necessary for control and monitor functions are continuously displayed by integrated and individual indicators at the work station. Data signals are routed from the signal conditioners to individual formatters as needed, such as amplifiers, converters, buffers, and drivers, for application to the display indicators.

Parameters needed less frequently are called up by the crew with a manual selector switch and applied sequentially to a panel-mounted voltmeter that serves as a time-shared general-purpose indicator. The data signals are hard-wired from the signal conditioners to the selector switch on the console. In addition, a portable cable is provided for accessing additional test points on the subsystems. This multiconductor cable is terminated at the selector switch and can

be manually connected to standard test plugs provided on the subsystems.

In the time-shared mode, the crewman selects, measures, converts to meaningful units, and evaluates the parameter with the aid of information supplied to him in the operator aids (manual, film strip, etc.).

A variation of this system is one in which all less frequently used test points are accessed through the manually connected cable. The selector switch is connected only to the cable terminal and serves to select individual cable conductors. This variation is identified in the data tables as System 1A.

6.2.2 System 2

This system, consisting of integrated individual, and time-shared elements, is shown in Figure 21. The system is interfaced with the data acquisition subsystem (DAS) and uses the data signal accessing, conditioning, and converting capability of the DAS for some of the parameters.

The crew-safety parameters are continuously monitored and automatically evaluated by limit detectors and go/no-go indicators and alarms as described for System 1. Also, parameters frequently checked or required for control or monitoring functions are separately formatted and displayed on individual indicators.

Parameters needed less frequently are manually selected, sequentially stripped out of the DAS, and displayed as a decimal number. This time-shared portion of the system consists of DAS interface with timing and control, a binary-to-decimal converter with indicator, and selector logic and control.

A data signal is obtained by selecting a test-point number with manual switches. The digitized signal value at this test point is stripped out of the DAS formatter when the selected channel is positioned, and is converted to decimal form and displayed to the crew. Operator aids are used by the crewman to evaluate the signal readings. Additional test signals can be manually accessed by the portable cable. This cable is manually connected to standard test plugs on the subsystems. A cable conductor selector switch and a multirange analog-to-digital converter are used to select and digitize the analog signal for application to the decimal indicator.

6.2.3 System 3

This system, shown in Figure 22, is interfaced with the DAS and consists of

FIGURE 23: System 4.

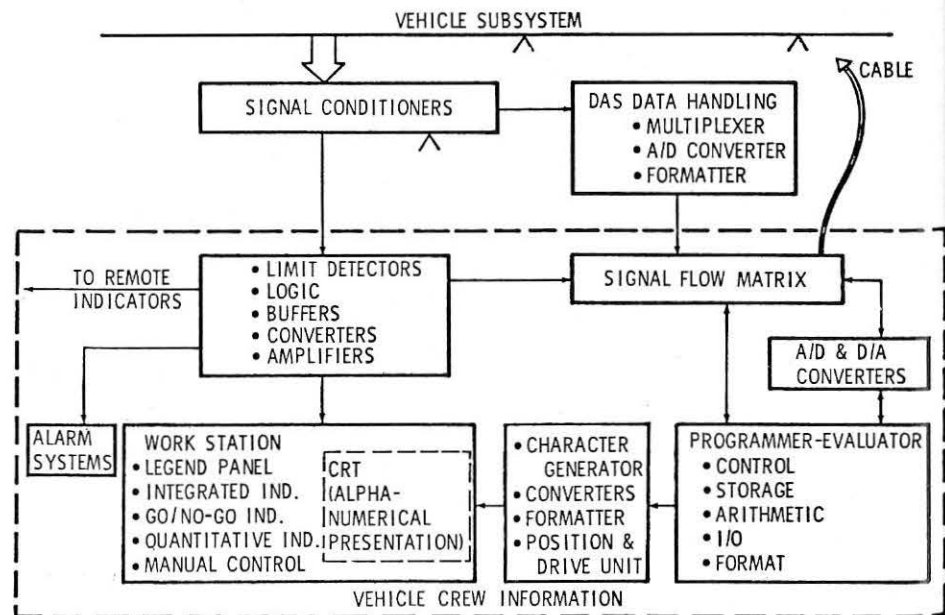

integrated, individual, and time-shared elements. A special-purpose programmer-evaluator automatically edits and evaluates applicable parameters and serves as formatter and controller for time-shared indicators.

The crew-safety functions are automatically monitored and evaluated as described for System 1. The programmer-evaluator also serves as a redundant detector for these functions. When any out-of-tolerance condition is sensed, the programmer-evaluator selects that signal and displays the quantitative value and identification information.

Parameters presented by integrated displays and those that require continuous display or are functionally related, are individually formatted, and presented by individual indicators.

The time-shared portion of the system consists of a special-purpose programmer-evaluator, a DAS interface unit, a signal flow matrix, an analog-to-digital converter, and an indicator and control panel.

The programmer-evaluator monitors the data collected by the DAS and the individual indicators and evaluates this data by digital comparison with predetermined limit values stored in memory. This automatic evaluation capability provides the crewman with routine house-keeping function checks and gives him information on the operational status of the vehicle subsystems. Manual selection control for calling up any given data signal or limit value is also provided.

A portable cable as described for System 2 is included for accessing additional test points.

6.2.4 System 4

The system in Figure 23, is interfaced with the DAS and consists of integrated, individual, and time-shared elements. It embodies a special-purpose programmer-evaluator that evaluates, edits, and formats time-shared parameters for display.

Parameters affecting crew safety are automatically compared with preset tolerance values by individual analog limit detectors (as described for System 1). A master alarm warns the crew when a hazardous condition occurs. Each detector controls a go/no-go indicator on the alarm panel to identify the malfunction. The programmer-evaluator also serves as a redundant detector for these functions. When an out-of-tolerance condition is sensed, the programmer-evaluator selects that signal and displays the quantitative value and identification.

Parameters presented on separate integrated displays and those requiring continuous display are individually formatted and presented by individual indicators.

The time-shared portion of the system presents combined qualitative and numerical data, line-type graphical information, or text-type messages on a

FIGURE 24: System 1—Equipment block diagram.

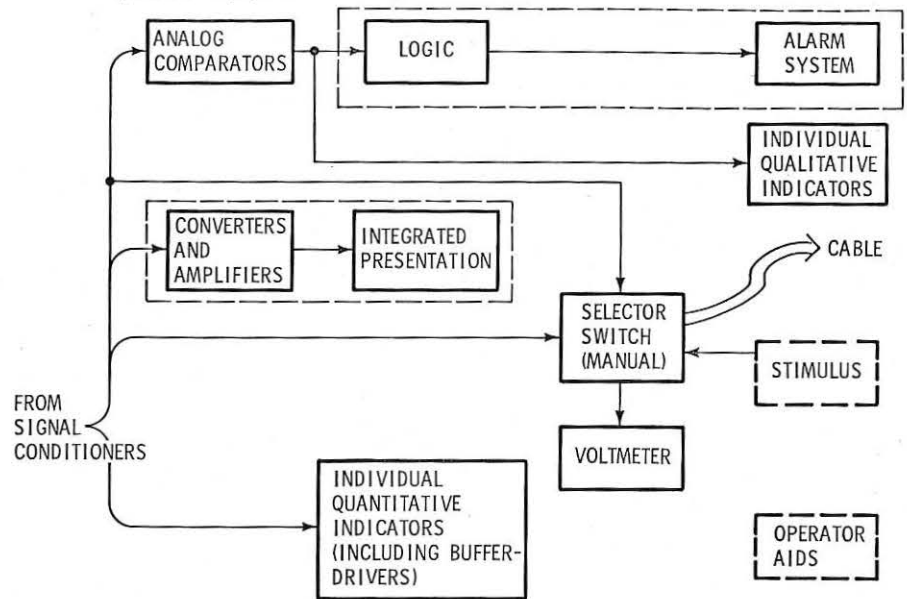

FIGURE 25: System 1A—Equipment block diagrams.

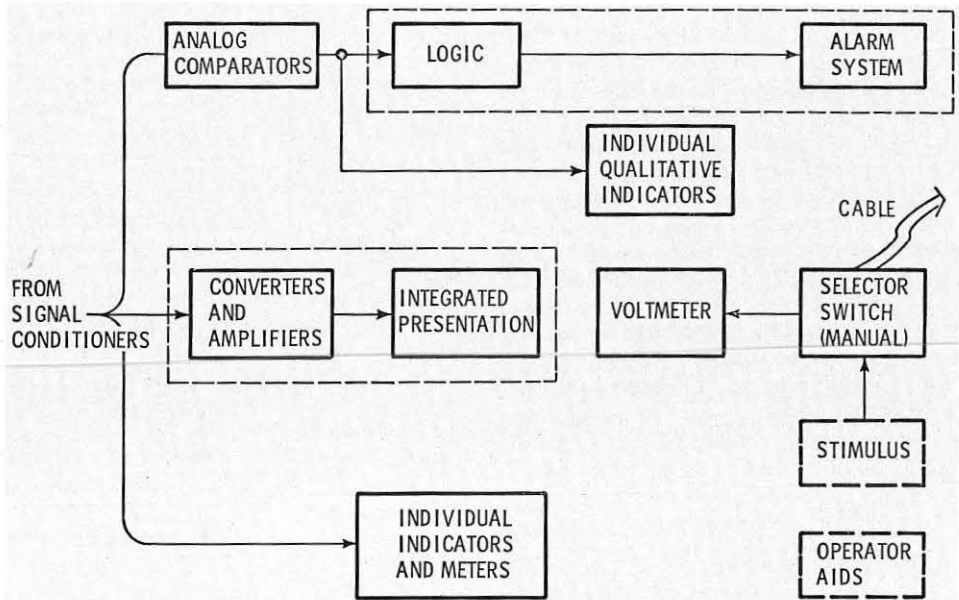
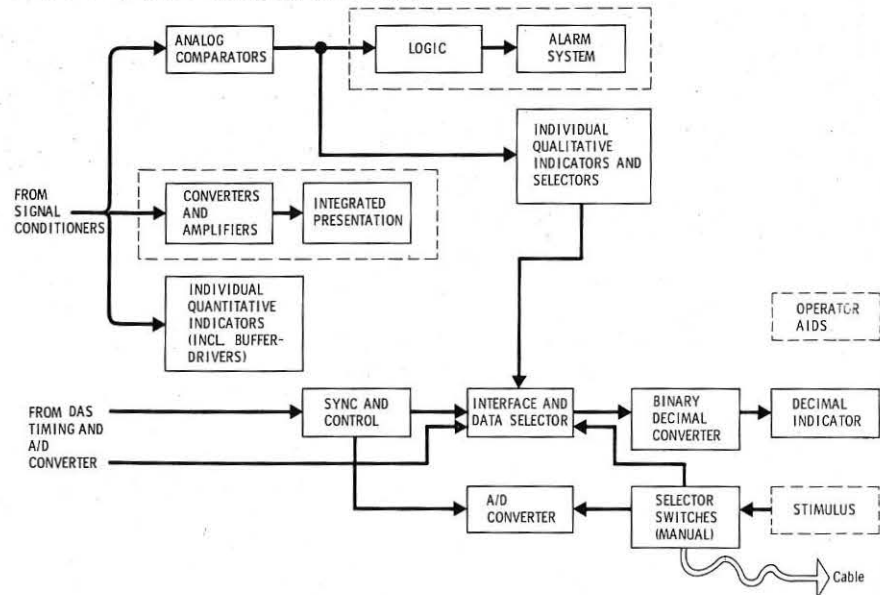

FIGURE 26: System 2—Equipment block diagram.



cathode ray tube (CRT) display. Display format, character generation repertoire, and measurement list content are under software control and are therefore extremely flexible. The system can perform scheduled evaluation to monitor resource management and can present integrated displays derived from related parameters.

The CRT display element consists of a special-purpose programmer-evaluator, DAS interface equipment, core memory, display generator section, incremental magnetic tape unit, CRT indicator unit, power supplies, and a control and alarm panel.

The programmer-evaluator monitors data collected by the DAS and by individual pickups and evaluates this data by digital comparison with predetermined limit values stored in memory. The display generator converts stored digital instructions and digital measurement values to analog CRT deflection signals to form alphanumeric characters and line segments. The tape unit loads measurement list limit and scaling data, display format control, character generator repertoire, and control instructions into the core memory and provides scratch pad storage of trend-type information. The core memory stores control data and digital display messages for flicker-free frame regeneration. The indicator unit has a manually-positioned overlay strip passing in front of the CRT's faceplate. The control and alarm panel contains system function and mode controls, measurement address selection, and forced-display alarm indicators and acknowledge switch.

A manually connected cable as described for System 2, is provided for accessing additional test points. A variation of this system is one that utilizes a general-purpose stored program sequencer instead of the programmer-evaluator. This system is identified in the trade data as System 4A.

6.3 Parametric Data

This section presents the parametric trade data for the alternate systems described in Section 6.2. This is done by: (1) identifying the hardware block diagram for each alternate system; (2) tabulating the hardware cost, weight, volume, and power parameters; and (3) plotting these parameters as a function of sizing and usage requirements.

6.3.1 Hardware Block Diagrams

Hardware or equipment block diagrams for each of the alternate systems described in Section 6.2 are shown in Figures 24 through 29. These diagrams show typical methods of implementation and are not intended to define a detail configuration.

Elements common to all systems are shown enclosed in dashed lines, except for the fault-isolation cable and selector switch. Although the latter are common

FIGURE 27: System 3—Equipment block diagram.

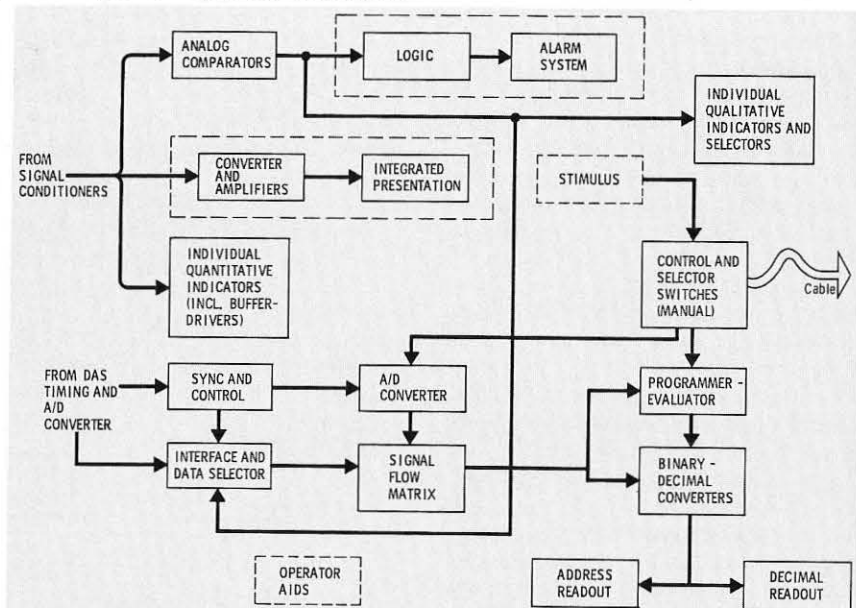

FIGURE 28: System 4—Equipment block diagram.

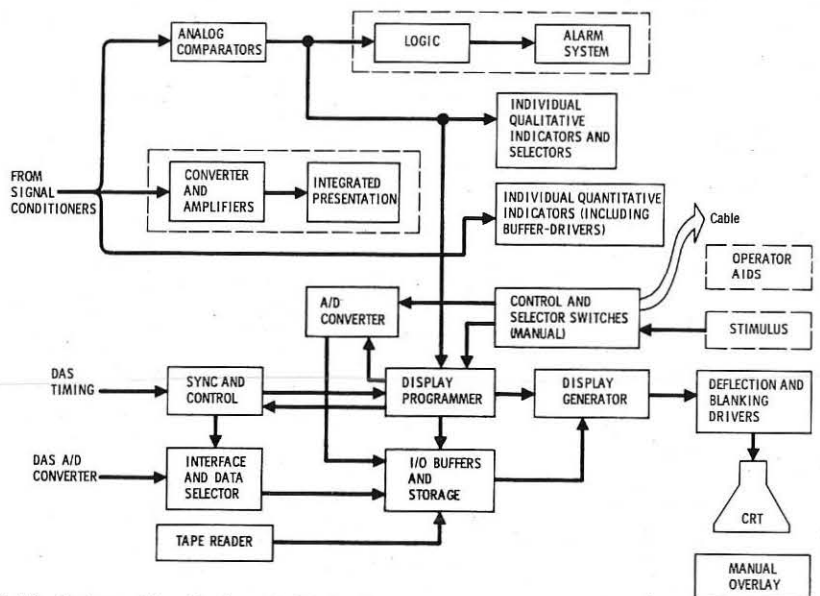

FIGURE 29: System 4A—Equipment block diagram.

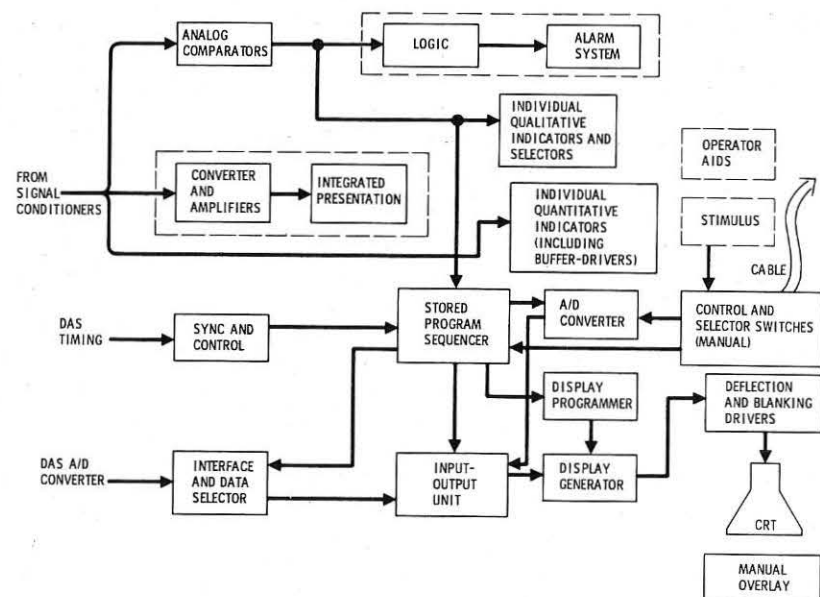

FIGURE 30: Parametric data.

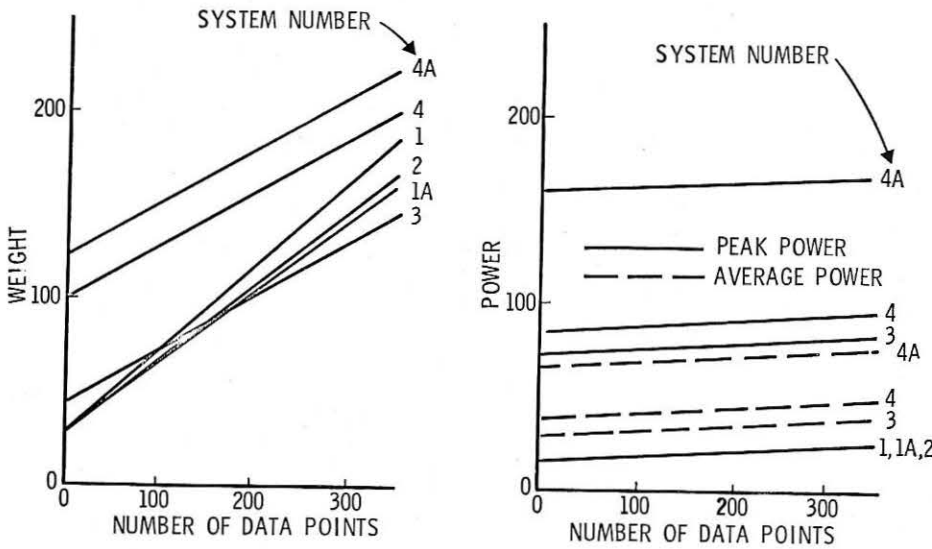
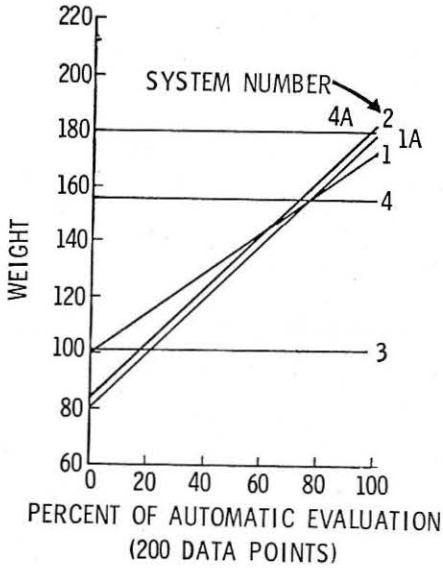

FIGURE 31: Parametric data.



to all systems, the method of evaluating the fault-isolation signals differs between the manual and automated systems.

6.3.2 Graphical Presentation of Parametric Data

Each system defined in Section 6.2 is designed to handle all seven parameter categories. Four kinds of capability are included in each alternate system: continuous automatic (analog comparator), continuous nonautomatic (meter), periodic automatic (programmer or analog comparator), and periodic nonautomatic (meter or digital voltmeter). To trade the alternate system on a weight, power, and volume basis as a function of the total number of parameters, the percentage of the total number of parameters requiring each of the four kinds of capability was calculated to be:

	Percentage
Continuous automatic	9
Continuous nonautomatic	2
Periodic automatic	10
Periodic nonautomatic	79

(These percentages would vary among space systems.)

All the systems provide for continuous qualitative and quantitative indication in the same manner. An individual analog comparator and go/no-go indicator is added for each continuous qualitative data point and an individual quantitative meter for each continuous quantitative indication. Due to the constant percentage of continuous functions, the weight and power of all systems increase linearly with the number of data points, as shown by the positive slopes of all curves in Figure 30.

In Systems 3, 4, and 4A, automatic evaluation is built in, being accomplished by comparison of the function against stored limits. The weight, power, and volume of these systems, therefore, do not increase as the number of automatically evaluated points increases. Systems 1, 1A, and 2, however, incorporate no storage capability; to automatically evaluate any function, an individual analog comparator must be added. The weight, power, and volume of these systems thus increase at a faster rate than Systems 3, 4, and 4A. This is shown in Figure 30 by the steeper slopes for Systems 1, 1A, and 2.

Systems 3, 4, and 4A have equal slopes because identical equipment must be added to each one for the continuous qualitative and quantitative functions. The slope for System 1 is less than that for 1A and 2 because the comparators added to System 1 for automatic evaluation are mounted on or near the control panel to save wire weight; in Systems 1A and 2 the added comparators are installed in the electronics bay.

Weight, Power, and Volume Versus Percent of Automatic Evaluation. Figure 31 shows the weight of all systems as a function of the number of data points that are automatically evaluated. The example figure contains the 200-data-point graph.

FIGURE 32: Parametric data.

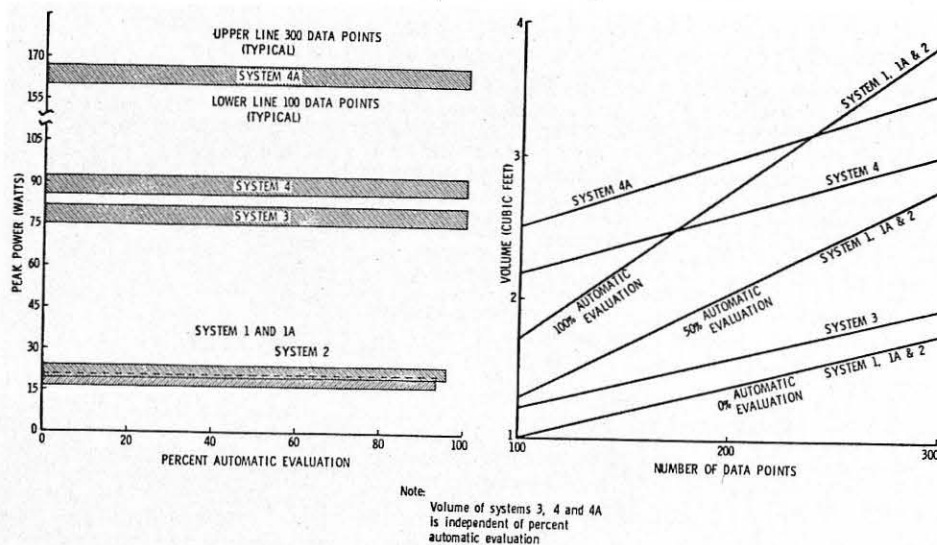

The graph for 200 data points was produced by considering 20 of the data points to be continuous qualitative functions, and 16 continuous quantitative functions. The remaining 164 were considered for automatic evaluation.

Figure 32 shows the volume and peak power requirements of all systems for varying degrees of automatic evaluation. These graphs were produced in the same manner as described above.

None of the above graphs include weight, power, or volume for the common elements.

Systems 3, 4, and 4A show constant weight, power, and volume because of the constant number (11 percent) of continuous qualitative and quantitative functions, and because automatic evaluation capability is built into these systems.

FIGURE 33: Hardware cost.

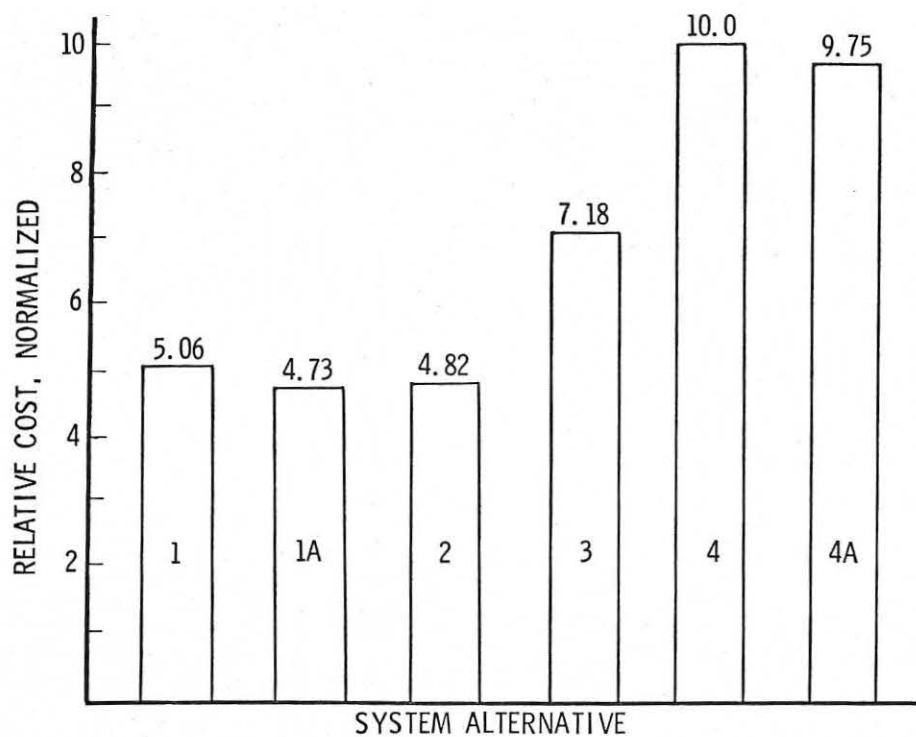

Systems 1, 1A, and 2 show increasing weight, power, and volume because, they automatically evaluate any function, an individual analog comparator must be added.

Systems 1A and 2 have identical slope because identical equipment must be added for the automatic-evaluation function. System 1 has a lesser slope than 1A and 2. In System 1, the required comparators are installed at or near the control panel to reduce wire weight, whereas in Systems 1A and 2 they are installed in the electronics bay.

Relative Costs for Systems. Figure 33 is a bar chart showing the normalized relative hardware costs for the design approach alternatives. The cost data for each of the systems was estimated from data accumulated from programs for similar types of systems and from existing vendor-supplied equipment and components.

Design-Approach Characteristics Matrix. Table 4 is a matrix considering the four design approaches described in Section 6.2 qualitatively.

TABLE IV: Design Approach Characteristics Matrix

	SYSTEM 1	SYSTEM 2	SYSTEM 3	SYSTEM 4
EQUIPMENT COST	LOW	LOW MED.	MED.-HIGH	HIGH
Flexibility	#1 Poor; required wiring changes. #1A Excellent	Good; dependent on VIS for time-shared parameters.	Good; dependent on VIS for time-shared parameters.	Good; accepts data from VIS control, formatting and presentation under software control.
Growth Potential	#1 Poor; requires wiring and structures changes. #1A Limited by crew time for large numbers of test points.	Excellent; permits use of building block concept to accommodate growth.	Excellent; hardware would require limited program changes	Excellent; hardware would not change, only software.
Convenience of Use	#1 Fair, #1A Poor; requires manual identification, selection, conversion to engineering units, and evaluation for time-shared parameters; probability of human error high. #1A requires manual cable for checkout.	Fair; requires manual identification, selection, units conversion, and evaluation for time-shared parameters; probability of human error high.	Good; Provides gross identification of time-shared parameter such as temperature, pressure, volts, etc. Requires manual selection and units conversion of time-shared parameters; probability of human error nominal.	Excellent; alphanumeric and message text readout; automatic or manual control of presentation; units conversion and arithmetic capability; presentation scheme allows "simultaneous" readout of several parameters (including time-shared); probability of human error low.
Evaluation Capability	Fair; crew safety parameters automatically monitored and evaluated; weight, power, volume, increase proportionately for additional auto-evaluation.	Fair; crew safety parameters automatically monitored and evaluated; others predominantly manually evaluated; weight, power, volume increase proportionately for additional auto-evaluation.	Good; crew safety parameters automatically monitored and evaluated; other parameters automatically evaluated on a Go/No-Go basis; hardware not significantly affected by number of parameters automatically evaluated.	Excellent; All parameters automatically monitored and evaluated; computational capability allows time-scheduled resource management; hardware not significantly affected by number of parameters automatically evaluated.
Crew Skill Level Req'd.	High	High	Medium	Low
Crew Time Required	High; becomes excessive for large number of checkout test points, or for high use rate of time-shared parameters.	High; becomes excessive for large number of checkout test points, or for high use rate of time-shared parameters.	Low for evaluation; little crew time required for Go/No-Go checkout. Medium for selection.	Low
Contribution to Ground Checkout	Poor; does not lend itself to use for ground checkout. Requires man on board for manual evaluation.	Poor; does not lend itself to use for ground checkout. Requires man on board for manual evaluation.	Fair; automatic evaluation capability can be utilized in ground checkout.	Good; system can perform large part of ground checkout with addition of auxiliary carry-on equipment.

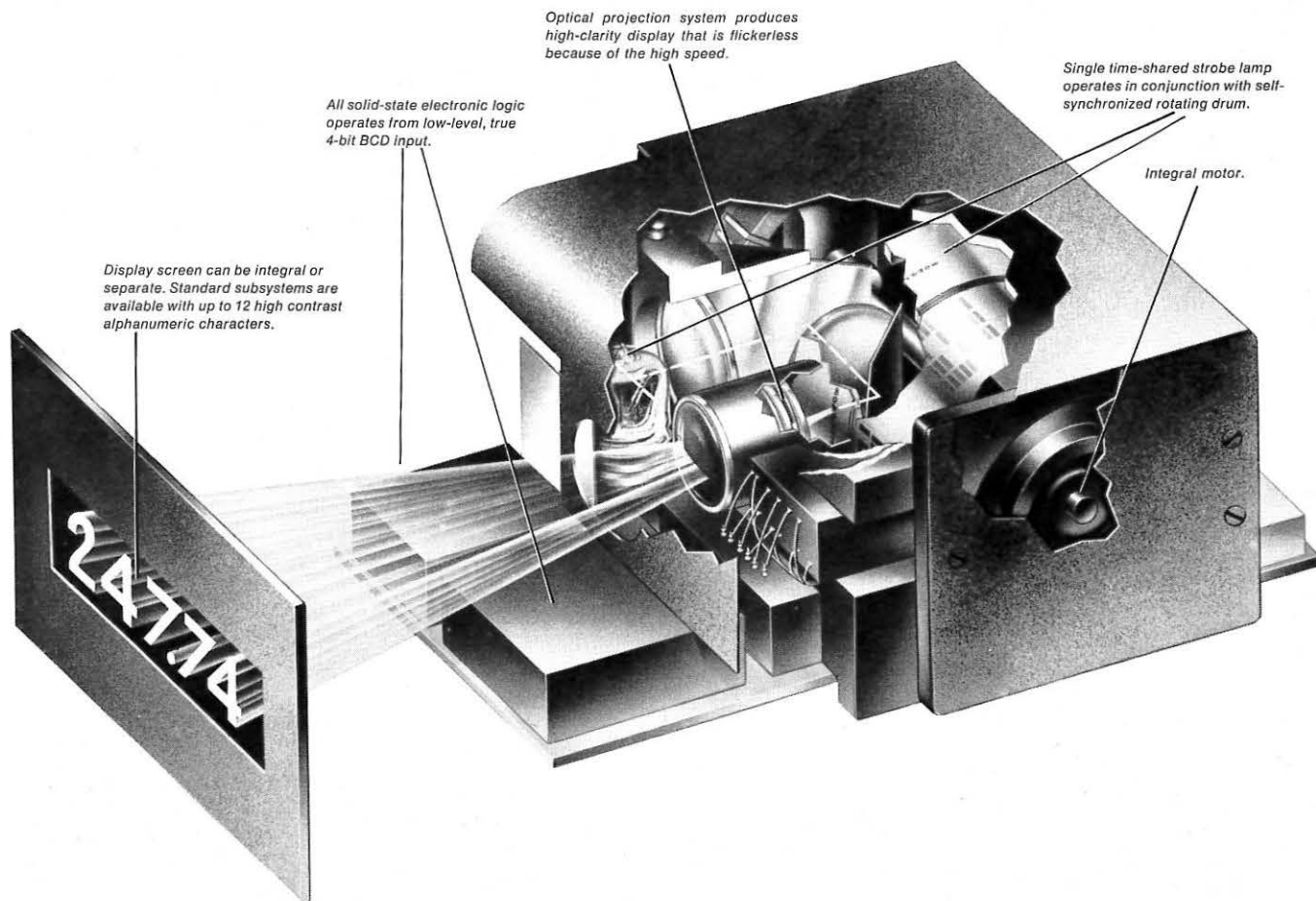

Now you can get more reliable readouts — at very low cost — with Raytheon's New Datastrobe* Digital Display

The Datastrobe subsystem employs a new concept of data display that offers you more reliable readouts and simple, flexible installations — at very low cost.

To produce high clarity displays, the Datastrobe subsystem utilizes (1) a single rotating drum operating in conjunction with a single time-shared high-speed strobe lamp (2) time-shared, self-synchronized all solid-state circuits, and (3) an optical projection to produce multi-digit, in-line and single-plane alphanumeric displays.

Reduced number of components increase reliability. Self-contained Datastrobe subsystem wires directly to logic without buffers or drivers. There are no signal amplifiers, switches or relays. One 6-digit Datastrobe subsystem can replace as many

as 66 incandescent bulbs or 6 electromechanical readouts!

Self-decoding eliminates wrong readouts. A self-decoding feature incorporated into the Datastrobe subsystem uses direct logic comparison to eliminate erroneous or ambiguous readouts. The conventional white-on-black displays are flickerless, provide high contrast and recognition.

Wide range of design options. Datastrobe subsystem display screens can be integral or separate. Standard models are available with up to 12 digits; floating decimal point is optional. Models with more digits and combinations of alphanumeric characters or symbols are available. Additional read-out locations are accommodated with simplified wiring.

*Trademark of Raytheon Company

... MORE NEW RAYTHEON DATA DISPLAY DEVICES



New side-view Datavue® Numerical Indicator Tubes (left) feature long life; low unit cost; less mounting depth; close spacing; large, bright character display. (Right) Special cathode-ray tubes, available in many sizes, combine electrostatic and magnetic deflection for writing alphanumeric characters while raster scanning.





For complete information on RAYTHEON DATA DISPLAY DEVICES — or for an operating Datastrobe subsystem demonstration — call your Raytheon Regional Sales Office or write to Raytheon Company, Components Division, Lexington, Mass. 02173

The next time somebody asks you why the talent is moving to the Independent Software Houses, quote him Bauer's Second Law.

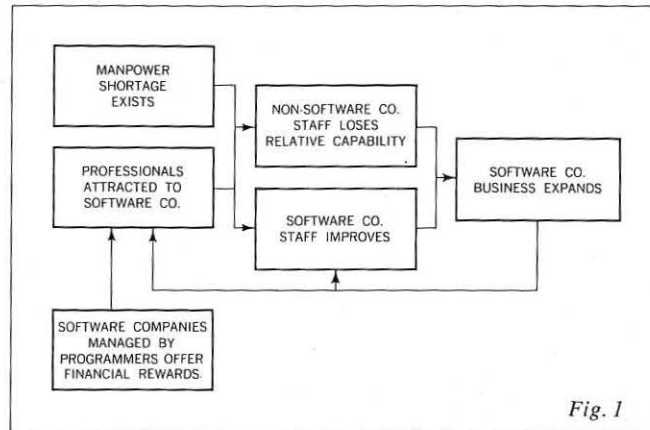

Fig. 1

Fig. 2: Dr. Bauer



Bauer's Second Law: Talent migrates from areas of well defined and stratified responsibility to areas of expanding activity at a rate proportional to the rate of expansion. Or, stated more simply:

talent goes where the action is.

COROLLARY

Independent software companies, those not associated with a manufacturer or user group, are attracting an increasing percentage of available programming talent.

MANPOWER SHORTAGE EXISTS

Our basic premise is that talent, especially top talent, is in limited supply in any field. In the software industry the demand for top-rated specialists exceeds the supply. Consequently, software experts have a choice as to where they work. At present, and with increasing frequency, they choose to work for independent software companies. This is not to say that you can't find very talented people employed by computer manufacturers or user organizations. You certainly can. But more and more of them concentrate in independent companies.

SOFTWARE COMPANIES, MANAGED BY PROGRAMMERS, OFFER FINANCIAL REWARDS

It is true that part of the attraction is financial. Independent software companies depend on talent for their livelihood and consequently are willing to pay for it in several ways. Empiricists please call.

PROFESSIONALS ATTRACTED TO SOFTWARE COMPANY

But specialists are attracted to the independent company by more than money. A professional, given his choice, would rather work among his fellows. It is always best to work where your contribution is essential to the success of the enterprise, a place where you feel yourself in the mainstream of the business. Furthermore, when a man and his

management are of the same discipline his needs are understood, his accomplishments rewarded, and his individual worth appreciated. Finally, working among top talent, a man can improve his own skills. This is especially true where people who have relatively narrow specialties within the basic discipline have a chance to exchange ideas and to learn from one another.

SOFTWARE COMPANY STAFF IMPROVES

For these reasons the staff of the independent software company improves, both in quality and in quantity. Since the talent pool is limited, it follows that the increased capability of the independents results in a decrease in the relative capability of non-independent software groups.

SOFTWARE COMPANY BUSINESS EXPANDS

This increase in capability brings more business to the independents. This in turn, makes it possible for the software company to offer more challenging work, more responsibility and more rewards. All this attracts still more talent. Thus the whole process repeats itself and becomes self-propagating.

IS THE INDEPENDENTS' GROWTH GOOD FOR YOU?

In five short years the independent software industry has grown from a meager \$5,000,000 annual business, to \$70,000,000 last year. And this year the figure is expected to double. Such growth must have sound economic reasons. There must be something the independents have to offer. There is. Stated in the simplest terms, the independent software firm can offer a pool of specialized talent which few users could afford to maintain for themselves. You can buy all this expert know-how, and use it for just as long as you need it to solve a given problem. And you will pay less than if you tried to solve the problem yourself. Furthermore, you will get the results on time.

HOW DOES INFORMATICS FIT IN?

Within our own organization (you knew the commercial was coming, didn't you?) we can call upon systems specialists, language specialists, experts in artificial intelli-

gence, in data retrieval, in PERT, and many more. Without even leaving the building. Now, this kind of talent doesn't come cheap. (Look at our payroll and at our salary incentive plan, unique in the software industry.) We're always busy working on the latest problems. Right now, about 80% of our work is in the new field of on-line computing systems. We sponsored the first national symposium on the subject together with U.C.L.A. (We'll be happy to send you some of the papers presented in return for the coupon, below.)

THE MORAL:

If you have read this far, you might be interested in talking to us further about our services, capabilities, and opportunities. Simply call (213) 872-1220 and ask for me, for Frank Wagner, for Bob Rector or for anyone else on our staff. If more convenient call Werner Frank at our Washington office (301) 654-9190.

● **informatics inc.**[®]
 ■ Department F
 ● 5430 Van Nuys Boulevard
 ■ Sherman Oaks, California

Please send me the articles checked below:

- On-line Systems—Their Characteristics and Motivations
- On-line CRT Displays: User Technology and Software

Name _____

Company _____

Address _____

City _____

State _____ Zip _____

An Equal Opportunity Employer.

P.S. IN CASE YOU'RE WONDERING, BAUER'S FIRST LAW IS: IF THE PROGRAM HAS A BUG, THE COMPUTER WILL FIND IT.

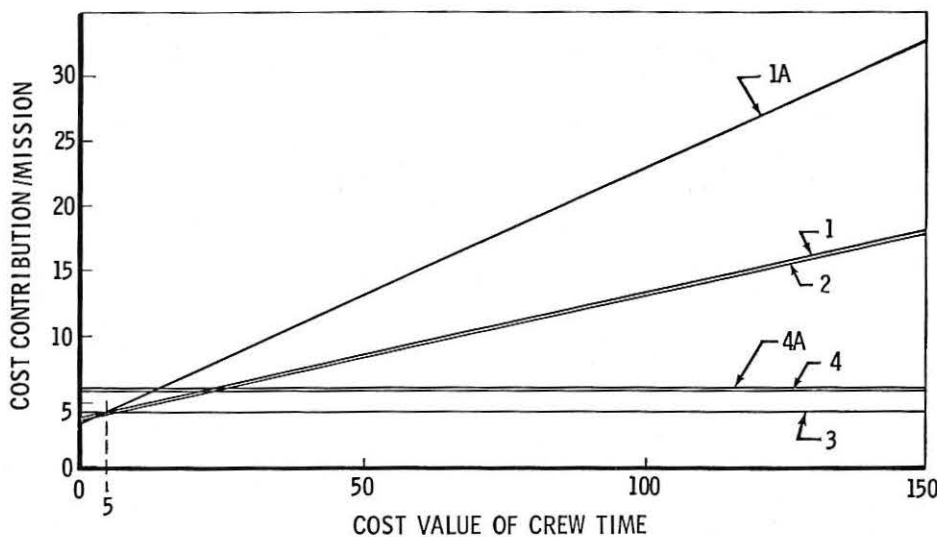

FIGURE 34: Crew time cost distribution.

6.4 Selection of Design Approach

Section 6.3 presented the parametric trade data for the alternate design approaches and the characteristics matrix. This section selects a design approach by fixing the total number of data points and the percentage of points of this total to be automatically evaluated. The data-point total was set at 200 test points (not including fault isolation), 20 percent of which require automatic evaluation.

The following discussion presents the analysis of the parametric trade data and the characteristics matrix that led to the selection of System 3.

Figure 30 shows a distinct advantage for System 3 over Systems 4 and 4A with respect to weight and a small advantage over Systems 1, 1A and 2 at 200 data points. System 3 also shows a significant advantage over Systems 4 and 4A and a small advantage over 1, 1A, and 2 with respect to volume at 200 data points. System 3 maintains the advantage over Systems 4 and 4A with respect to peak power and average power, but suffers a slight disadvantage to Systems 1, 1A, and 2 with respect to average power and a nominal disadvantage with respect to peak power. The advantages of System 3 with respect to weight and volume offset the minor disadvantages of power. Hence, System 3 is selected with respect to these parameters.

Figure 31 presents the weight of the alternate systems as a function of the percentage of test points that are automatically evaluated for the 200-data-point

over all alternate approaches except where the percentage of automatic evaluation in Systems 1, 1A, and 2 approaches zero.

The design-approach characteristics matrix (Table 4) supports the parametric data in the selection of System 3. This system offers significant advantages over Systems 1, 1A, and 2 with respect to convenience of use, crew time required, and contribution to ground check-out. The impact of the disadvantages suffered by System 3 to Systems 4 and 4A with respect to convenience of use and evaluation capabilities are felt to be diluted when considering the additional weight penalty to be paid for obtaining the additional capability.

In addition to the hardware characteristics and associated costs, there is a significant cost relationship based on the cost value of the crew time required to use the display system. An analysis was conducted to determine the time required by the crew to use each of the alternate display systems. This crew-time-value use relationship is shown in Figure 34.

The final selection of a system is dependent on a total cost-effectiveness comparison (Figure 35).

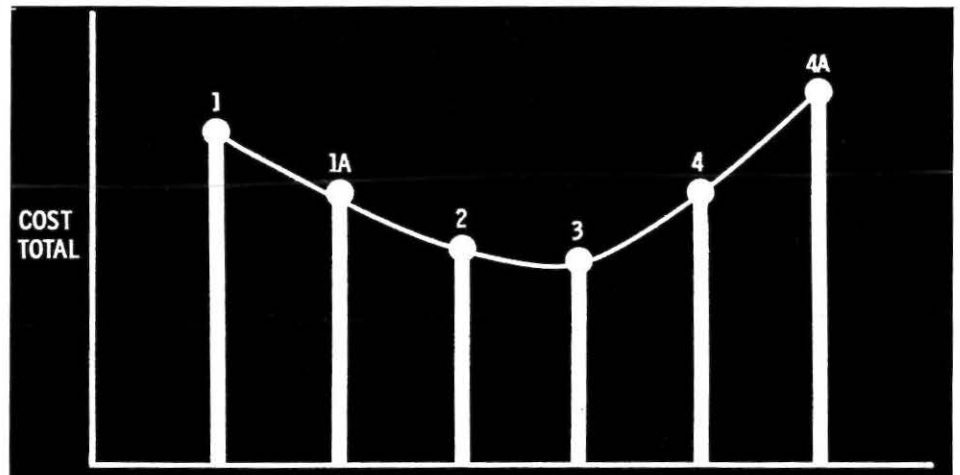

FIGURE 35: Cost total = Hardware cost + weight cost + power cost - cost value of crew time.

group. The 200-data-point figure shows that System 3 has a weight advantage for the number of points beyond 40; hence, System 3 is selected from the standpoint of the weight as a function of the automatic evaluation required.

Figure 32 shows that Systems 1, 1A, and 2 have a significant advantage over 3, 4, and 4A with respect to peak power and that this advantage is largely independent of the percentage of the total data points to be automatically evaluated. The disadvantages that System 3 suffers with respect to peak power is not felt to bear considerable weight since average power is a more realistic measure. System 3 is again shown to maintain the advantage with respect to volume

Acknowledgments

I wish to express my appreciation to those many people who contributed to the generation of the data that made this paper possible. Particular credit should be given to: B. J. Pugh, C. W. Greer, W. E. Smith, J. A. Dinnetz, D. W. Barton, J. H. A. Forrester, W. A. Hurt, F. J. Parente, U. J. Volk, and B. I. McCaffrey.

Many thanks to the people of the Boeing Aerospace Audio-Visual organization for their excellent assistance.

This paper was presented at the Sixth National Symposium on Information Display held in New York City, October 1965.

Two-Color Display System

by John S. Frost

Summary

Two-Color Display techniques, where two primaries are used to generate a near full spectrum of mixtures, are described in detail. The theoretical background, including principles of Chromatic Adaptation and Induced Colors are presented, together with an analysis of hue, saturation, and lightness interrelationships sufficient to afford prediction of results. A brief review of pertinent applications is given.

Introduction

Color is used in display systems to increase the information content of the presentations. The requirements for color are persistent, and often outweigh disadvantageous engineering trade-offs in the areas of cost, reliability, size, and weight. In certain cases it is possible to relax hue and saturation specifications and achieve considerable improvement in system economy. The two-color approach described in this article is a technique where only two (rather than three) primary colors are used, while a nearly full spectrum of desaturated mixtures is produced. In this analysis it is seen that additional components required to effect these results are induced at the retina by the process of chromatic adaptation. The background required for prediction of these results is given below, together with examples showing where two-color systems may be used to advantage.

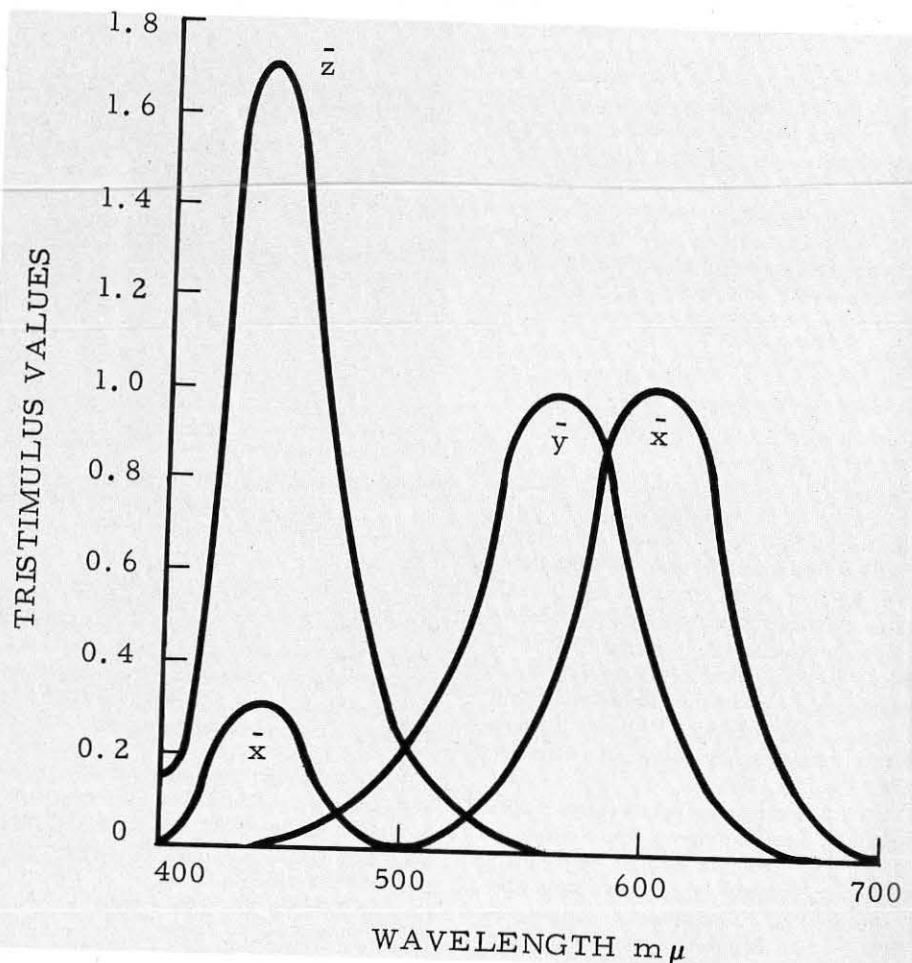

FIGURE 1: Spectral characteristics of standard colors (\bar{x} , \bar{y} , and \bar{z} refer to the red, green, and blue primaries, respectively. Ordinates are chosen so as to define the peak of the \bar{y} curve as 1.0).

Ground Rules of Colorimetry

In the analysis of two-color systems, standard colorimetric methods may be used. A quick review of pertinent principles follows. Figure 1 represents the spectral content assigned to the three colors used as standards for colorimetry. These are unreal colors, in the sense that such relationships do not exist in nature, but are defined so as to afford matching of all real colors by their additive mixtures. Thus all colors may be represented as consisting of specific proportions of these standards. The percent of \bar{x} and \bar{y} components can be indicated in Cartesian coordinates, with the percent of the \bar{z} component automatically defined as $1.0 - \bar{x} - \bar{y}$, conveniently restricting the plot to two dimensions. Such a plot is known as a Chromaticity Diagram and is shown in Figure 2.

Here the spectrum locus is shown, defining the bounds of real colors, while the standard colors are indicated by the points (0, 1), (1, 0) and (0, 0). The equal energy point E (0.33, 0.33) defines the color "white," while illuminant "C" forms a good approximation to natural daylight.

Hue, the dominant wave length of a color, is determined by the intersection of the spectrum locus with a line originating at the illuminant and passing through the color point. The proximity of the point to the spectrum locus, measured along this line, defines the saturation or strength of the color.

Several interesting characteristics of the Chromaticity Diagram are apparent. The mixture of two colors is specified along a straight line connecting points defining the colors, the distance from either point varying in inverse ratio to the amount of that component. In addition, the relative luminosity of the sample is indicated by its ordinate, since the \bar{y} curve of Figure 1 was chosen to correspond with the standard luminosity curve.

Lightness

The Chromaticity Diagram allows the specification of hue and saturation. An additional parameter, that of lightness, may now be introduced as a third dimension, producing a "Color Solid." Lightness refers to the mental perception of reflectance, and may be referred to a graded series of neutral grays (Figure 3). Objects exhibiting chromatic reflectance evoking the same sensation of lightness as one of the gray chips are

FIGURE 3: Graded series of neutral grays (used in the measurement of lightness).

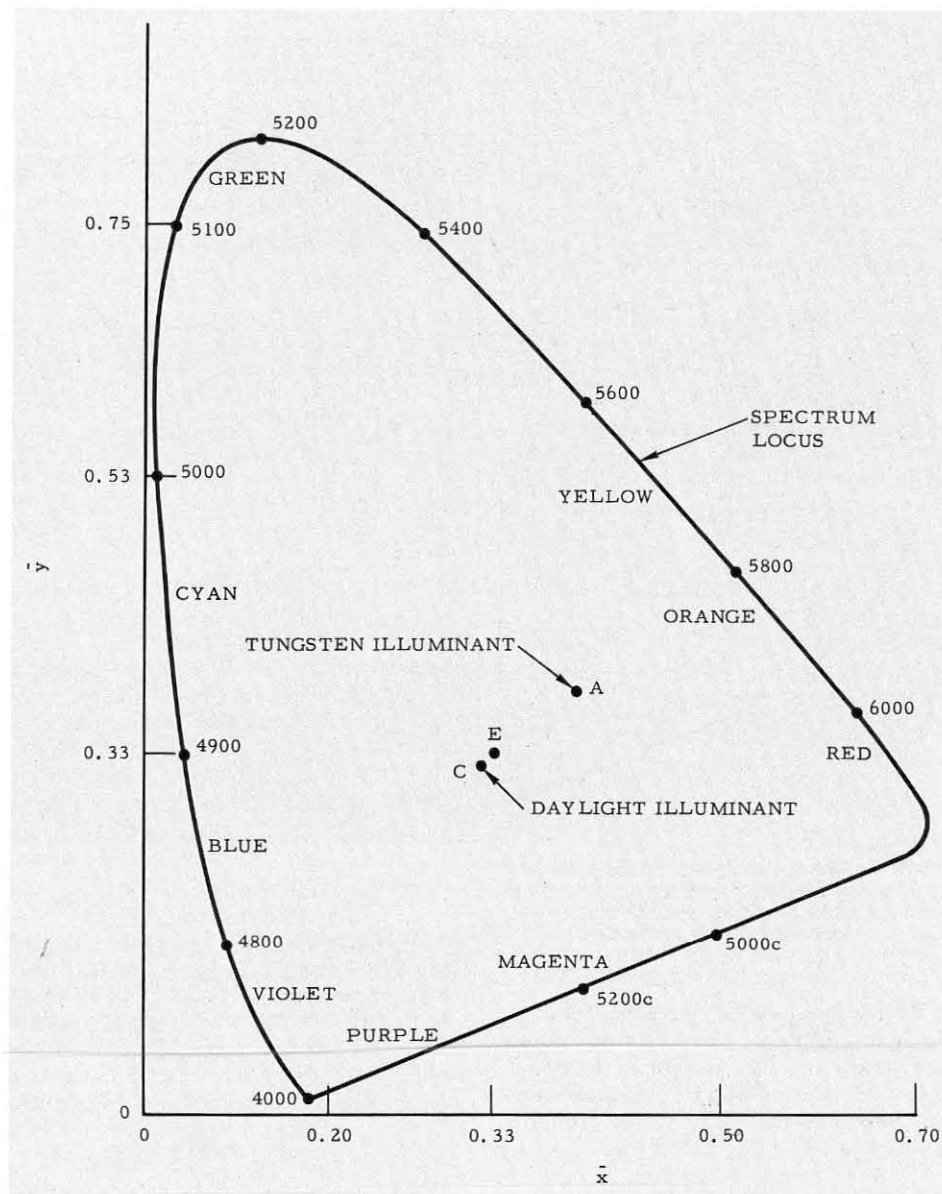
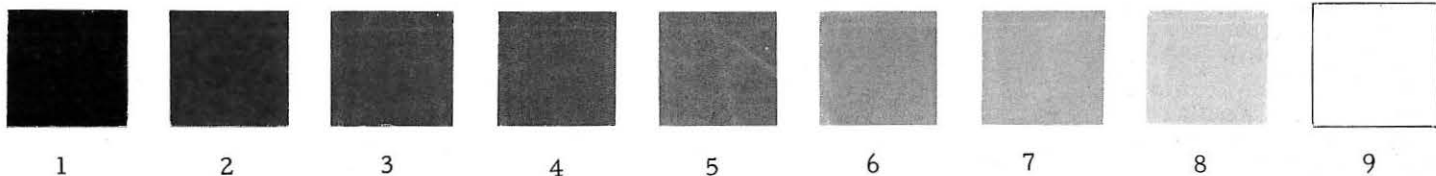

FIGURE 2: Chromaticity diagram. (Hue designations and associated wavelength of the spectral colors are noted along the periphery of the spectrum locus. All colors of natural objects may be matched by mixtures of the standard colors and represented by points within the spectrum locus.)

assigned a position on that quantitative scale. The Munsell system of color notation utilizes this parameter in the following manner: Hue, Value/Chroma, where Value refers to lightness of the sample, and Chroma is the purity or saturation. It should be noted that lightness, being a ratio of reflected incident light, is independent of brightness over the normal range of intensity.

Lightness and saturation are to an extent mutually dependent insofar as the former is the ratio of incident to reflected light and the latter represents the degree of inequality of wavelength distribution in the sample. It follows, for example, that high saturation and high lightness are mutually exclusive since some absorptance is required to effect unequal wavelength distribution. In fact, the color solid appears more like a sphere than a cylinder, where hue is the angular displacement, saturation is the length of the radius vector, and lightness is measured along the vertical axis (Figure 4). Both the Munsell and Ostwald systems utilize this concept.

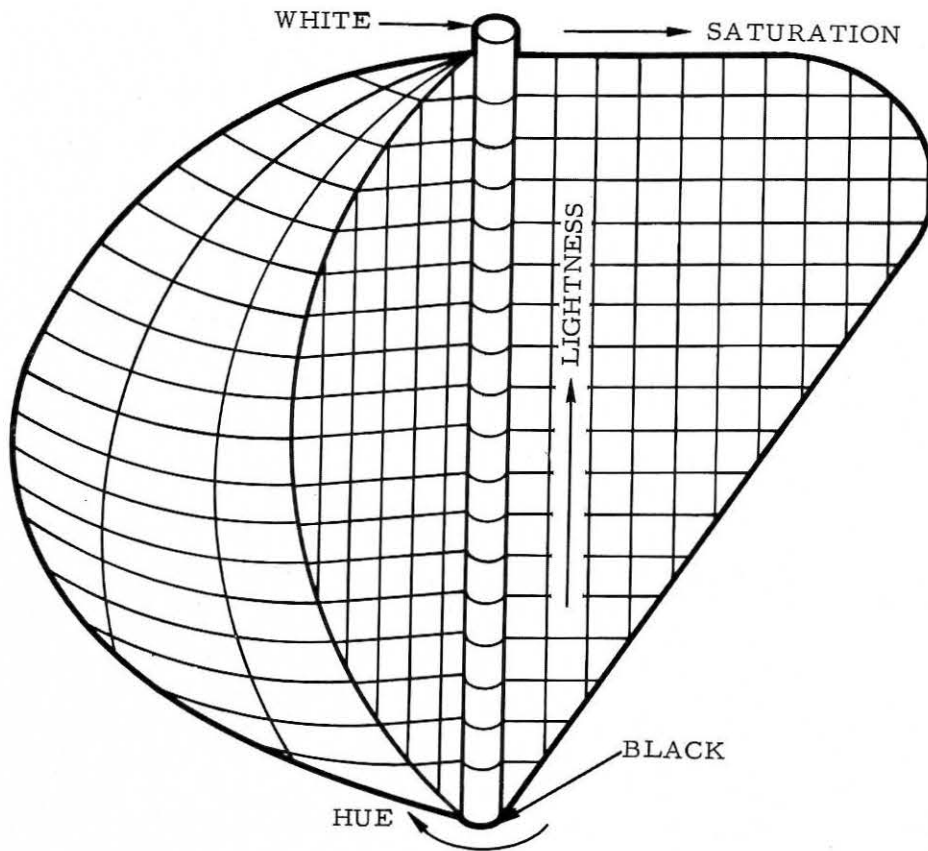

FIGURE 4: Color solid (Munsell system). (All real colors can be expressed in terms of hue, saturation, and lightness and assigned a position in the solid.)

In the analysis of projected or self-luminous displays, we substitute brightness terms for the concept of lightness, since luminous intensity emanates from the display surface and is not primarily a function of object reflectance.

Chromatic Adaptation

From the above discussion, it is apparent that under normal circumstances a two-color system is capable only of presenting the two primary colors generated by the system, together with additive mixtures thereof. Such is the case with the Hughes Two-Color Storage Tube¹ and early versions of the General Electric Schlieren Light Valve,² where green and red primaries are used, and yellow mixtures are available. Such a system might be termed one-dimensional, since all chromatic outputs lie on a single axis connecting the two primary components. In order to achieve a full range of hues, at least one additional primary must be added. Two-color systems generate this additional requirement by chromatic induction, a psychophysical process which takes place at the retina of the observer. The induced color takes the form of the complement of the average color of the prevailing illuminant, and is discernable only under specially contrived circumstances, such as that of Figure 5.

In Figure 5, the average illumination on the screen is reddish, being a mixture of red from the first projector output, and the unfiltered tungsten output from the second projector. Due to the parallax of the system, two shadows are cast by the object onto the screen. Where

FIGURE 5: Demonstration of chromatic adaptation (area 'A' appears blue-green to the observer).

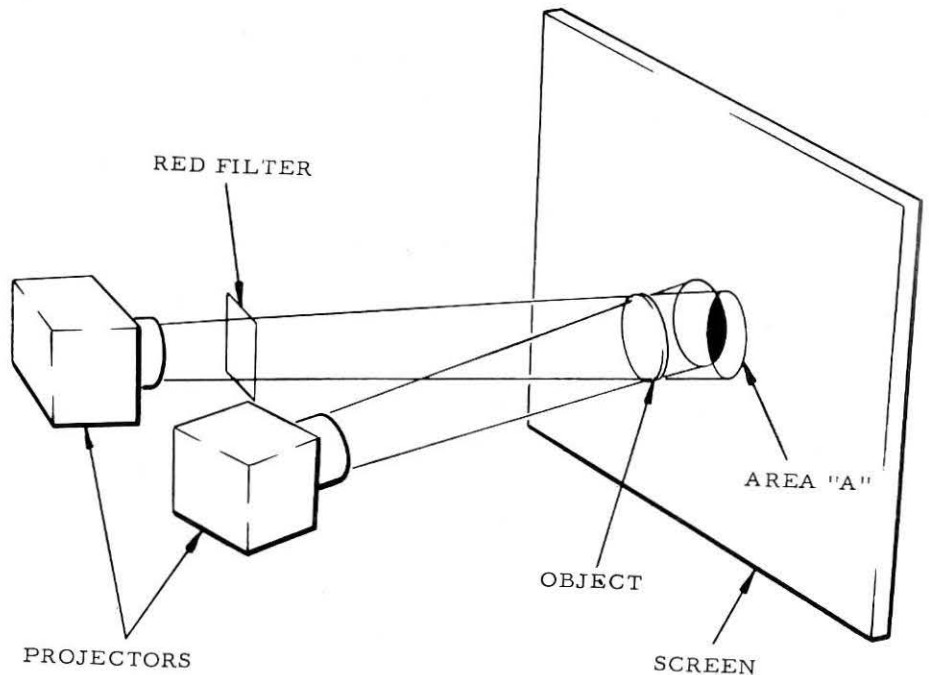

the shadows overlap, the area is dark but two fringes are noted, both with definite chromatic content. One of the fringes is red, owing to the lack of tungsten illumination in that area. The other fringe, however, appears as a moderately saturated blue-green and is due to the observer viewing the achromatic portion of the display in the context of an overall reddish illuminant.

The process at work here is a normalizing phenomenon which operates to preserve the object-color relationship of the perceived object. Huseyin Yilmaz³ has probed the process from an evolutionary standpoint and states "Color perception with three independent attributes (hue, saturation, and brightness) for each object helps us classify and recognize the surrounding objects. It may be assumed that color vision evolved due to its survival value for the organism. It follows . . . that color classification of natural objects must, in general, remain nearly invariant when the amount and spectral composition of the illuminant changes, as it does from sunrise to sunset, or from direct sunlight to the interior of a cave. Otherwise the ability to perceive color differences would be useless, even confusing."

The physiological mechanisms responsible for this process are readily postulated. For example, considering the Young-Helmholtz theory, where three disparate cone sensitivities are assumed, normalization would ensue from a differential change in receptor sensitivity in response to analysis of the spectral content of the illuminant.

Thus, the retinal process at work in Figure 5 is one of decreasing the relative sensitivity of the red sensors in response to the predominantly red content of the

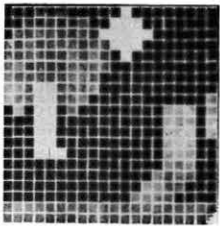

(a)

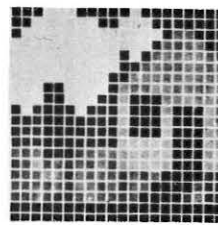

(b)

FIGURE 6: Color separation positives of a low resolution natural scene (photograph 'a' was taken through a red filter, and photograph 'b' was taken through a green filter).

illuminant. The energy characteristics of the tungsten emission is perceived in this case as minus red (blue-green).^o The normalizing process is termed Chromatic Adaptation, while hues produced by such overcompensation are referred to as induced colors.

Projection of Color Separation Transparencies

A more sophisticated and potentially useful demonstration than that of Figure 5 can be effected by supplying prestructured intensity patterns at the projector gates by means of specially prepared photographic transparencies. Such patterns are readily effected by making color separation positive transparencies of natural or artificial scenes of varied chromatic content. In the example of Figure 6, a low resolution scene was constructed from highly saturated color chips and photographed through red and green Wratten filters. Shades of gray are thus effected in accordance with the intensity of the reflected energy from the various chips in the bands passed by the filters, and subject to the wavelength sensitivity of the film that is used. Reproduction of these patterns in the manner of Figure 5 (in exact registration on the screen) will result in a variety of mixtures of red to cyan, including gradations of lightness corresponding to the amount of photometric energy impinging on the retina of the observer.

Complementary hues exist "in the shadow" of the primary, being produced in the areas where the unfiltered component is dominant. A variety of shades will ensue, depending on the relative intensities of the components. In those areas of the displayed scene where the brightness of the primary color is less than that of the unfiltered component, the complement will predominate. The example of Figure 5 can thus be seen to be a special case of this technique.

Maximum available saturation of the complement is dependent on the relative amounts of filtered and unfiltered energy

^oIn actual fact, the perceived color deviates from the complement of the filter characteristics to the extent that tungsten illumination, rather than an equal energy source is used for the demonstration. This deviation will be disregarded in the ensuing discussion, although it can be shown to be responsible for minor discrepancies between theory and observed phenomena.

impinging on the screen. That is, the chromaticity of the illuminant will determine the degree of chromatic adaptation that will ensue.

Saturation of the color occurring in any specific area of the screen is a function of the amount of mixing occurring between the primary and complementary hues. Balanced inputs at any brightness level will effect achromatic results with a lightness corresponding to the total brightness of the components. For any specific pattern, brightness measurements can be taken and the above discussion verified quantitatively.

Cross Modification Of Color Projections

In the previous example, the unfiltered projection has been devoid of chromatic content. The next step is to effect

a practical two-color system using two well saturated primaries. In this case both projectors are filtered and generate colors corresponding to and complementary to these filter colors at the screen.

This is the method used by Edwin H. Land^{4,5} in his extended series of multiple projection experiments concerned with the generation of a full spectrum of colors from two primaries only. An excellent review of Land's work, together with an analysis of results, in classical terms, is given by Judd⁶.

An approximate method for determining the result of this mixing is to consider each component to react separately around the equal energy point and then superimpose results additively. That is, if we note the effects of each half-filtered pair (one projector unfiltered), and then add the results obtained, using the standard methods of colorimetry, they closely correspond to the observed colors produced by dual filter projections. This method is illustrated in Figure 7 for the case of yellow-green and orange filters, and indicates the saturation limits of the desired colors.

FIGURE 7: Cross modification of color projections shown in three dimensions. (In this example, orange and yellow-green primaries are reacting to produce darker complements. Cross-mixing is effected in all areas, and is noted as green and magenta in those places where a reasonable balance occurs. All colors produced are restricted to the specific plane in the color solid as shown.)

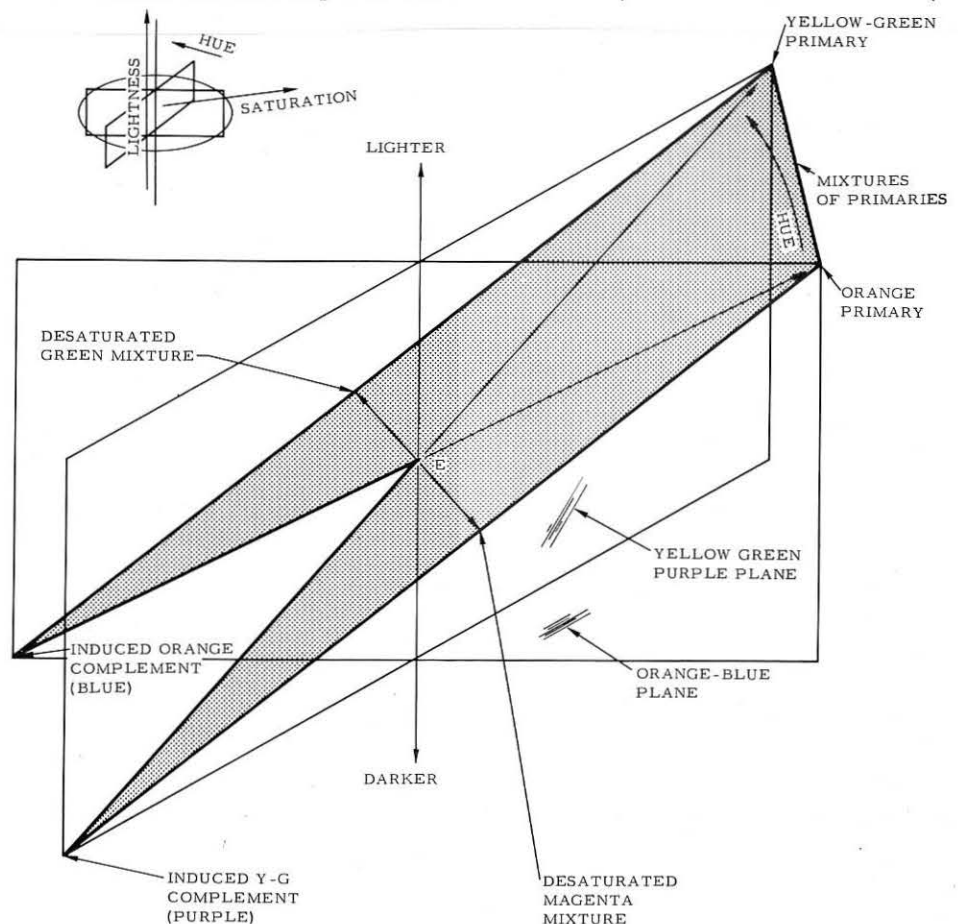

In actual fact, the results do not approach the limits in the area of the complements, since a degree of brightness from the opposing primary is required for complement generation. The three dimensional pot does, however, illustrate the relationship between lightness and available hues. Since the complements exist by virtue of the absence of primary illumination, they are necessarily darker than the primaries. Intermediate hues are of intermediate lightness, being formed from a complement and the opposite primary. Saturation of mixtures can be seen to be limited by the near-complementary nature of mixing components. This particular choice of filters, incidentally, yields good results since the resulting colors are brighter in the yellows (mixtures of primaries) and darker in the blues (complementary tones). This corresponds to the subjective observation that the best yellows are light and the best blues are dark.

Thus, by the appropriate scheduling of intensity of but two chromatic components, a wide range of color outputs can be attained. Hue, saturation and brightness are mutually dependent, while the choice of primaries, the range of desired outputs, and the shape of the chromaticity diagram are seen to affect the results.

Applications

As an intermediate step in the two-color process, color information is transformed into black and white intensity records of the wavelength bands of interest. Subsequent reconstruction is described above. In many cases involving the photographic process, the lower cost of the black and white film is important. When color information is to be transmitted from a remote acquisition source, the savings in system complexity may be of significance. A two-color system restricts the acquisition transducers to two narrow portions of the spectrum, and the conversion and transmitting equipment is of relatively narrow bandwidth.

For example, earlier methods of outerspace color sensing involved the measurement of the entire visual spectrum, normally resulting in the transmission of large quantities of excess data. Two-color systems, utilized in this capacity, restrict visual data to permit unmanned space vehicles to make observations in color

about a wider variety of subjects with smaller and lighter equipment. The information is transmitted over narrow band circuits and is reconstructed by dual projection or similar methods.

Since this article is primarily concerned with display techniques, passing mention only will be made regarding photo interpretation systems utilizing two-color systems. In this case, contrast is more important than fidelity, and the subjectively generated colors and the color mixtures serve to provide additional information to the observer.

In the area of color reconstruction, two chromatic sources must be used. One interesting method, developed by Hashimoto⁷, utilizes the filtered output of two black and white TV receiver tubes. Two 14 inch CRT's are used, mounted with their viewing ends at 90 degrees to each other, and a 45 degree semi-mirror is used to form the composite image. Red and cyan filters are employed, yielding reasonable saturation for most colors, and failing to reproduce purple only. Circuitry has been developed to afford operation of the system from the standard color signal.

Recently, a two-color receiving tube has been announced.⁸ Two guns and two phosphors are used, instead of the usual three. Phosphors with improved chromatic characteristics are deposited with precision to yield greater color fidelity. Price of the tube is said to be considerably lower than existing color tubes on the market.

Inexpensive color moving pictures were developed in the 1930's, using the two-color concept. These have since been superseded by full color renditions due to the high requirements for color fidelity existing in the entertainment field. A discussion by Hirsch⁹ concerning the use of two-color systems in commercial television systems reflects this feeling as well.

In some cases, such as electroluminescent displays, full color capability is difficult to attain by standard methods, due to inherent limitations in the medium. In the example of electroluminescence, color shifts over a narrow range are possible by varying the a-c frequency supplied to the display surface. However, if this shift is employed to define the primaries in a two-color system, a multi-color display can be effected. Complements of the primary colors are generated in the darker areas, and mixed with the opposing primaries. A frame-sequential presentation of the primary patterns is required due to the existence of a single display surface. In a recent series of tests, six colors of moderate saturation were reported¹⁰.

Hard copy records, in color, of subjectively produced two-color displays are not readily effected, due to the fact that a camera does not have the chromatic adaptation capabilities of the human retina.^{9*} However, when required, the induced complements can be furnished by an additional pair of projectors. With all four projectors registered on the screen, the resultant appears overcompensated to the eye, but can be accurately recorded onto color film. In ordinary circumstances, the black and white transparencies would serve as satisfactory records, but color hard copy may be required for publication purposes, or for display in standard systems, such as closed circuit color television. In addition, the above system permits enhancement or revision of the color renditions by supplying overly saturated "complements" of any hue desired.

References

1. L. S. Yaggy, et al., *Two-Color Storage Tube*, IEEE Trans. Electron Devices, March 1963 - pp. 63-68.
2. MELVA (Military Electronic Light Valve) 412L System—General Electric Publication EHM-1275, March 1961.
3. Huseyin Yilmaz, *Color Vision and a New Approach to General Perception*. Biological Prototypes and Synthetic Systems, Plenum Press, 1962; also, *On Color Perception*, Bulletin of Mathematical Biophysics, Vol. 24, 1962.
4. E. H. Land, *Experiments in Color Vision*, Scientific American, May, 1959.
5. E. H. Land, *Color Vision and the Natural Image*, Proc. National Academy of Sciences, V. 45, Nos. 1 and 4, 1959.
6. D. B. Judd, *Appraisal of Land's Work on Two-Primary Color Projections*, Journal of the Optical Society of America, March 1960, Vol. 50, No. 3, pp. 254-268.
7. K. Hashimoto, *Color TV Based on Land Theory Uses Two Single-Gun Tubes*, Optoelectronic Devices and Circuits - McGraw-Hill, New York, 1964, pp. 340-341.
8. Electronic News, November 22, 1965, TI, *Polaroid Join on TV Color Tube*, p. 1.
9. Charles J. Hirsch, *The Effect on Color TV of Dr. Edwin H. Land's Color Experiments*, IRE Trans. Broadcast and TV Reviews, November 1960, pp. 5-12.
10. John S. Frost, *Generation of Subjective Colors in an Electroluminescent Display*, IEEE Trans. Industry and General Applications, Vol. IGA-1, No. 5, pp. 361-365.

*E. H. Land found it possible to photograph red and white projections with results similar to that given by the human eye. In this case a blue-sensitive film was used (4, 5). In this section, however, we are not considering projections where one component is broad-band.

Intensity-Modulated Recorders

by Harold Klipper

FIGURE 1: Operation of intensity-modulated display.

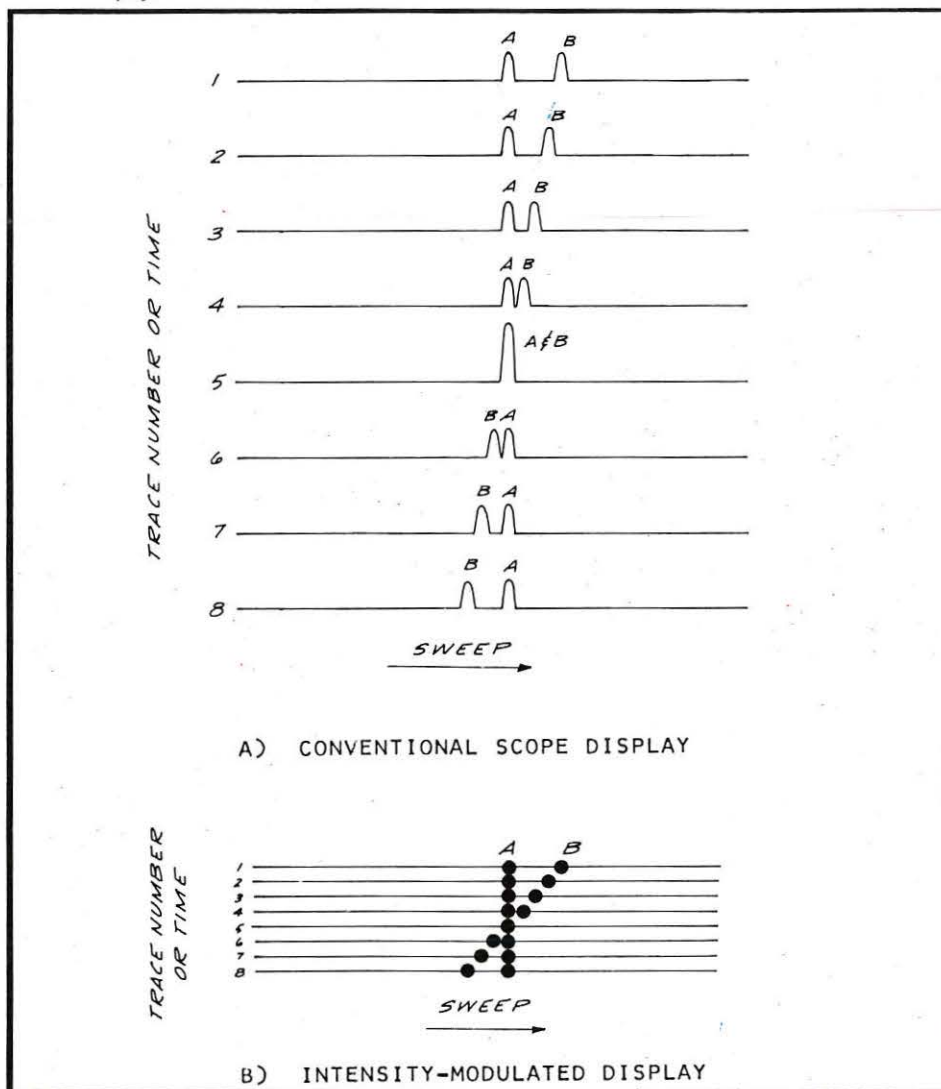

General

Increased activity in the collection and analysis of large quantities of data has pointed out the great advantage of wide-bandwidth, intensity-modulated permanent displays. By arranging successive sweeps side-by-side, the intensity-modulated display permits the immediate interpretation of the time-history of large quantities of data and improves the ability to detect signals below noise. The enhancement of signal detection is better than the one-half power law normally associated with postdetection integration, and is approximately the 0.8 power.

Theory of Operation

The operation of the intensity-modulated recorders can best be understood by reference to Figure 1. Figure 1a shows eight successive sweeps of a conventional display. Each sweep contains two signals, A and B, which appear as amplitude deflections on each sweep. One signal, A, is stationary with respect to the start of the sweep (trigger), while the second signal, B, is moving relative to the start of the sweep. Figure 1b shows the intensity-modulated record which would be generated for these eight successive sweeps. The sweep is initiated but remains blanked as it moves across the face of the CRT. When the signal appears, the trace is intensified (unblanked) and appears as a dot. This dot is exposed to photographic film or paper, which is moved a distance of one dot width between sweeps. The next sweep then exposes a dot next to the previous one, leaving a continuous trace of the time history of that signal.

Since the film motion is very small (the width of a dot) for each sweep, many thousands of sweeps can be placed on a very short strip of film, condensing the data onto a very short record. Typically, if the conventional scope display were photographed with only 0.5 inches between traces, then one thousand sweeps would require 500 inches of film, as compared with 10 inches for the intensity-modulated record, with a spot size of 10 mils.

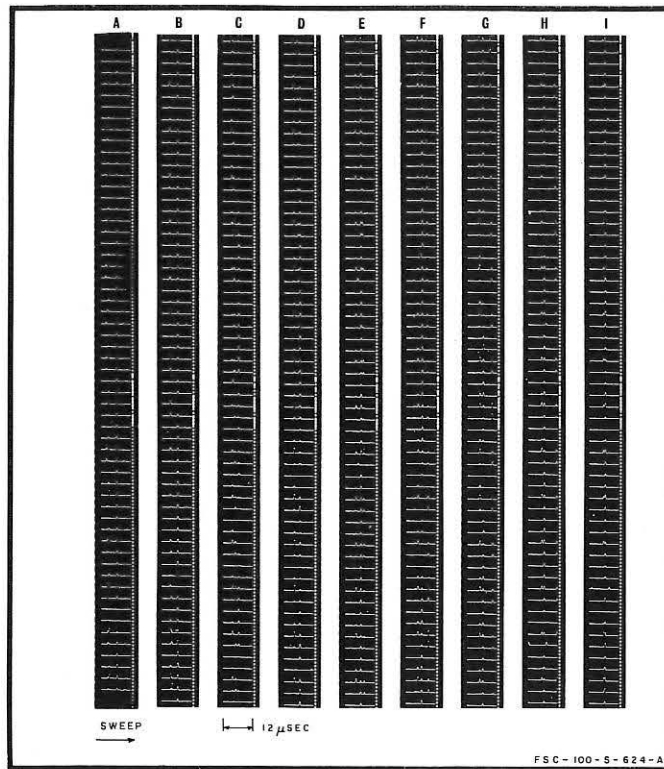
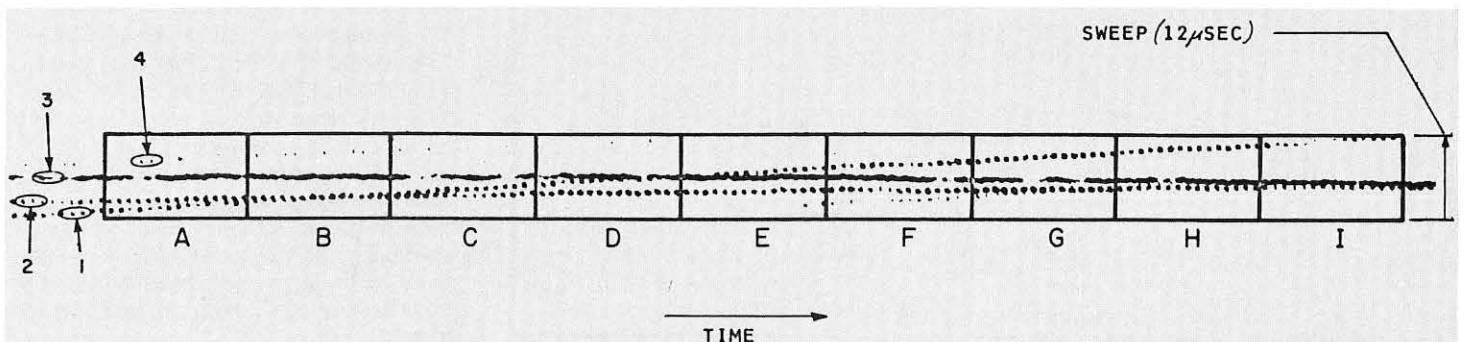

FIGURE 2: Conventional scope display.

The main advantage resulting is not the saving of film, but the easing of the very difficult task of evaluating 500 inches of film and attempting to determine the time history of all signals present. Performance of this task by an experienced individual would take many hours, whereas the same information is obtained at a glance from the 10-inch intensity record.

The difficulty of reading the conventional scope display is illustrated in Figure 2, which contains the information presented in approximately 500 conventional scope displays, and shows four signals moving relative to the start of the trigger. These signals are of different amplitudes, cross each other and, at times, even fade out completely. It would usually take a long time to extract the exact time history of all four signals, but this information can be obtained instantaneously from the intensity record of the data shown in Figure 3.

FIGURE 3: Intensity-modulated display of data shown in Figure 2.



Improvement in Signal-Detection Threshold

In addition to greatly simplifying the recovery of the time history of the signals, the intensity-modulated recorder improves the signal-detection threshold. This improvement is a result of integration which takes place in this type of record. Perfect predetection integration improves the detection threshold in direct proportion to the number of signals integrated (αN). Postdetection integration (as might be obtained by repetitively superimposing the signal and the noise on film or on an oscilloscope with a long time-constant phosphor) improves the detection threshold in approximate proportion to the square root of the number of signals integrated ($\alpha N^{1/2}$).

For many signals, side-by-side integration, as obtained with the intensity-mod-

ulated recorder described in this paper, is superior to postdetection integration, improving the detection threshold in proportion to the number of signals integrated raised to the 0.8 power ($\alpha N^{0.8}$).¹⁻⁴ Figure 4 shows the detection threshold improvement as a function of the number of signals integrated. Figure 5 is a reproduction of a typical recording of the improvement in signal-detection threshold achieved with this type of recorder. It should be noted that for signal-to-noise ratios below about 6 db, the signal is completely buried in the noise on a conventional scope display.

This type of recorder has one additional advantage over other forms of postdetection integration: Since it tracks the signal at the same time that it performs the integration, it will improve the detection for nonstationary signals. Many other forms of postdetection integrators require that the signal remain stationary or follow a previously known variation in order to perform the integration.

FIGURE 4: Signal-integration efficiency.

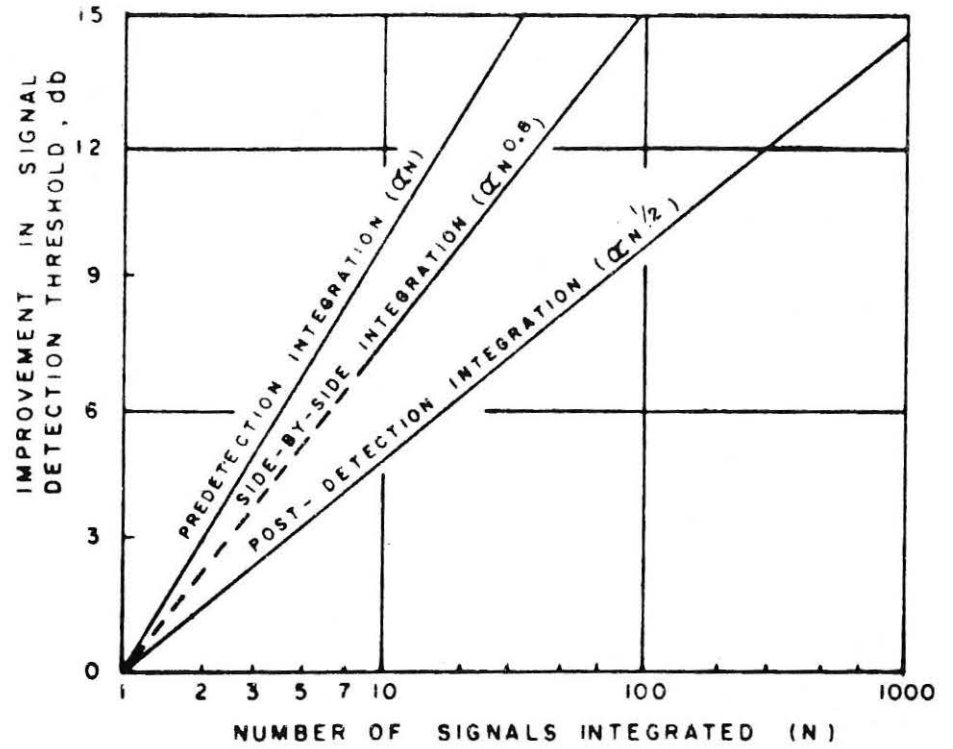
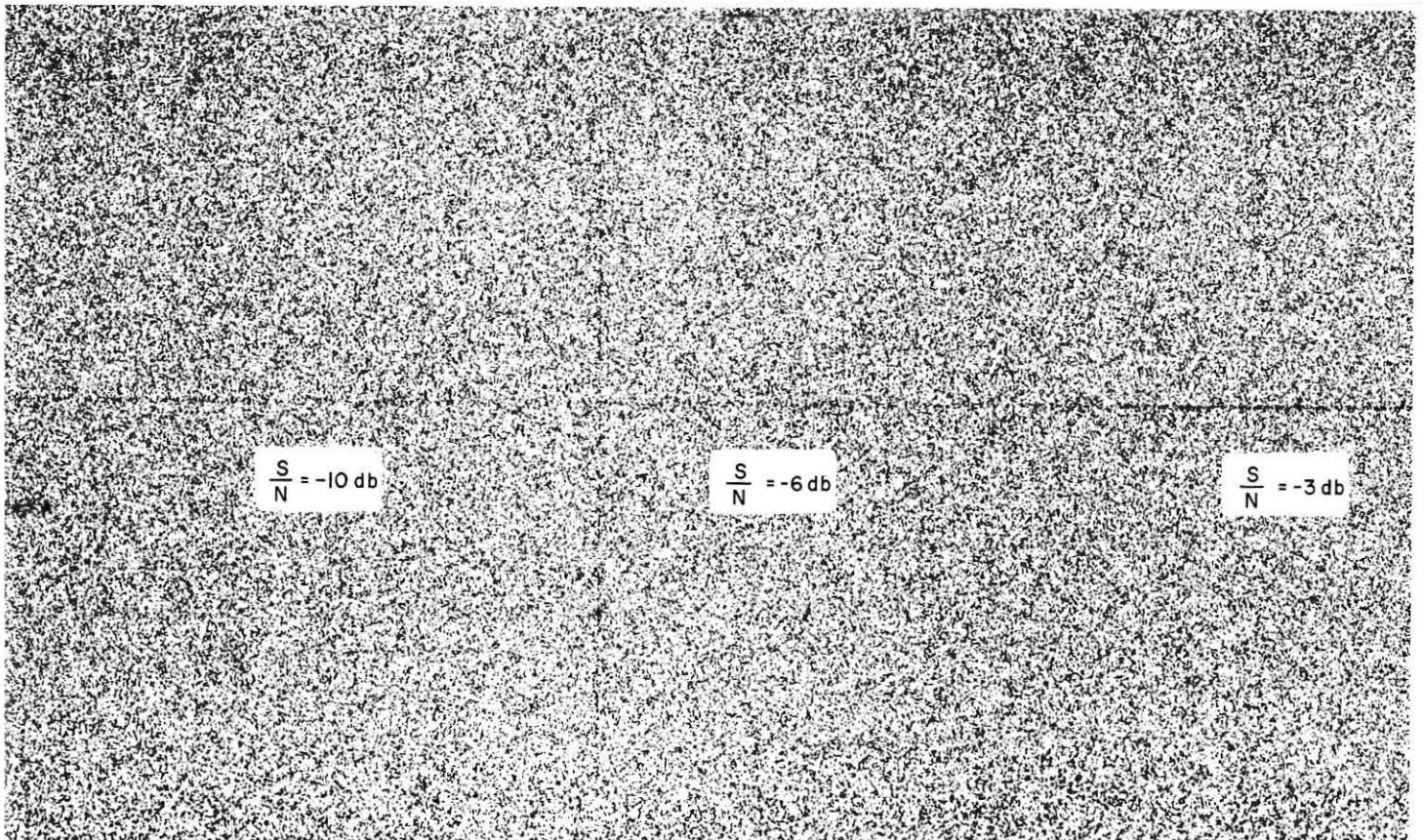

FIGURE 5: Reproduction of typical recording of improvement in signal detection achieved with Intensigraph™ 200.



SELECTROSLIDE PROFESSIONAL PROJECTORS

— the most versatile
automatic
slide projectors
on the market



MODEL SLX-750—96 slide
Random Access—Eleven
models to choose from

Selectroslide offers more exclusive features—and more flexibility—because Spindler & Sauppe builds the only complete line of professional projectors and accessories. Check the broad range of capabilities:

Random access instantly projects any selected slide, regardless of sequence.

Digital readout—displays slide number to audience or lecturer for notation and recall or review (exclusive with Selectroslide).

Film strip attachment—converts from slide to film strip projection (exclusive with Selectroslide).

Slide Commander—radio controls slide change up to 150 feet from projector.

Speed Dissolve changes images without darkening screen; lends an appearance of animation to still slides.

Multiple screen, or split screen effect achieved by proper arrangement of multiple projectors.

Rear projection with special wide angle lenses (17 lenses and 1200 watts available).

Sound synchronization attachments available for use with any tape recorder. Special continuous playbacks for exhibits.

Remote command—permits slide change and other cue signals to operator.

Write for **FREE** condensed catalog on the complete line of Selectroslide products.



spindler & sauppe inc.
1329 grand central
avenue / glendale
california / 91201

Paper or Film Speed

With intensity-modulated recorders such as those described above, the film or paper speed is a function of the spot size on the final record. Successive sweeps may be displayed with varying amounts of overlap, or with an actual space between them. As discussed above, where successive pulses are superimposed upon each other, they expose the same emulsion on the photosensitive medium, resulting in a less efficient integration effect than is obtained by placing the traces side-by-side. For most applications, however, the optimum operation of the recorder includes a combination of overlap and side-by-side displaying of the data. Figure 6 shows the required paper or film speed in inches per second versus the data rate for various amounts of overlap (assuming a spot size of 0.010 inches on the final record). Figure 7 is an expanded version of Figure 6, for low data rates.

Resolution and Linearity

The resolution of this type of recorder is determined by the spot size on the record, and is defined as the number of line pairs on the actual record. Spot sizes for most electrostatic CRTs lie between 0.015 and 0.025 inch, with some special tubes available having slightly smaller spots. Magnetically focused and deflected CRTs are available with spot sizes of 0.001 to 0.002 inches. If there is an optical system between the CRT and the photosensitive medium, the magnification must be taken into account in determining the spot size on the record.

The required resolution is determined by the application. The greater the resolution, the more signals can be identified across the record, the easier it is to distinguish two adjacent signals, and the more accurately the position of the signal with respect to the start of the sweep can be determined. To obtain the maximum resolution, it would seem desirable to use the largest CRT with the smallest spot size. If this is done, however, the problem of sweep linearity is introduced.

The smallest spot sizes are available in magnetically-deflected CRTs. In these tubes, the spot position is proportional to the tangent of the deflection angle. Since the deflection angle is linear with the current in the deflection coil, the spot position is not linear with the drive current unless the deflection angle is kept small. Keeping this angle small is not feasible in large CRTs, such as 10-inch tubes. There are techniques for improving the linearity of the sweep, but the net linearity and stability are not always satisfactory.

The next choice then is to use a magnetically-focused CRT of medium size. Typically, a CRT with a 4-inch useful screen and a 20-degree deflection angle can produce a 0.1-percent linearity, and a spot size of 0.002 inches. This should result in a resolution of 1000 lines. It would normally be difficult to see 1000 lines over the four inches, but this pattern can be optically magnified without affecting either resolution or linearity.

An alternative approach to obtaining resolution and linearity is to use a CRT with a fiber-optic face plate. These tubes are available with spot sizes of 0.002 inches across 8½ inches, yielding a resolution of over 2000 lines. The deflection of this tube would normally not be linear over the 8½-inch width, but it is possible to restore the linearity by properly shaping the inside surface of the fiber-optic face plate. This would yield a very linear deflection, and would result in a greater resolution than is obtainable with the smaller tubes. The fiber-optic CRT also has the advantage of eliminating the optical system required with the normal CRT. The cost of this system, however, is greater because of the much more expensive tube employed.

Applications

There are a large number of applications for which this type of recording is very advantageous. Typically, for radar data recording, the video is employed to intensity-modulate the CRT, and the sweep is made proportional to range. The resultant record consists of a composite of individual lines representing radar range, time, and video amplitude or target cross-section.

This type of record is ideal for rapid evaluation of radar data: It is a material aid in seeing targets with very small cross sections (low signal-to-noise ratios); it automatically yields the range history of the target; it shows target trajectory crossings; and it gives an indication of relative target cross sections and scintillation rates. When installed at a radar site, this recorder provides a real-time, high-resolution, 12-inch-wide record which can substantially increase the speed in rendering immediate evaluation reports. A reproduction of a typical multitarget radar signal recorded on an Intensigraph recorder is shown in Figure 8.

The Intensigraph is also employed in speech analysis. It produces a display of formant energy peaks (after spectral analysis) versus word duration. This type of display is generated by utilizing frequency as the horizontal sweep; energy amplitude to intensity-modulate the CRT; and lateral film motion to provide the time base. Such a recording capability in real time provides an invaluable aid to researchers in this field.

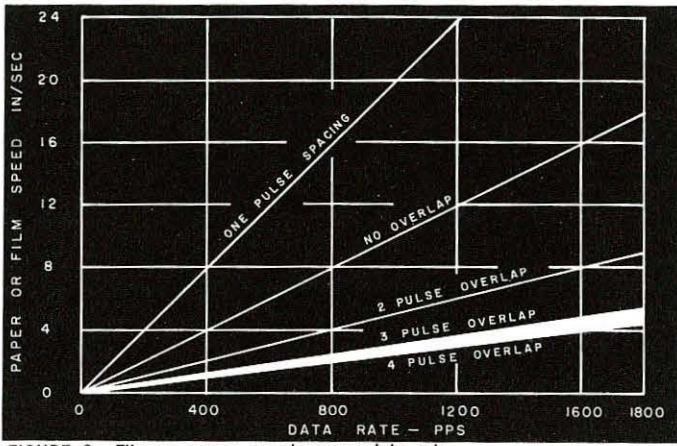

FIGURE 6: Film or paper speed versus data rate.

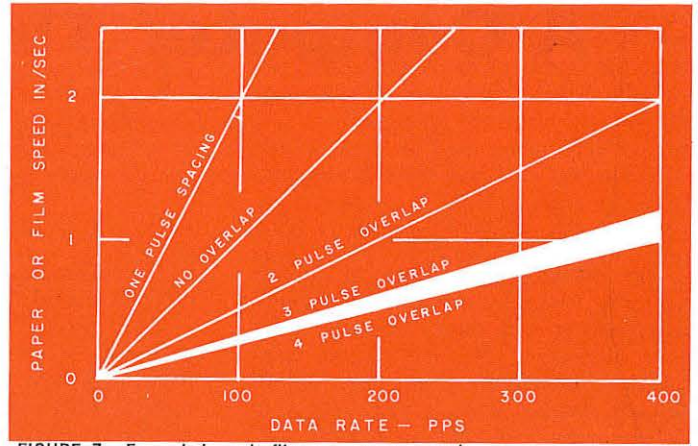
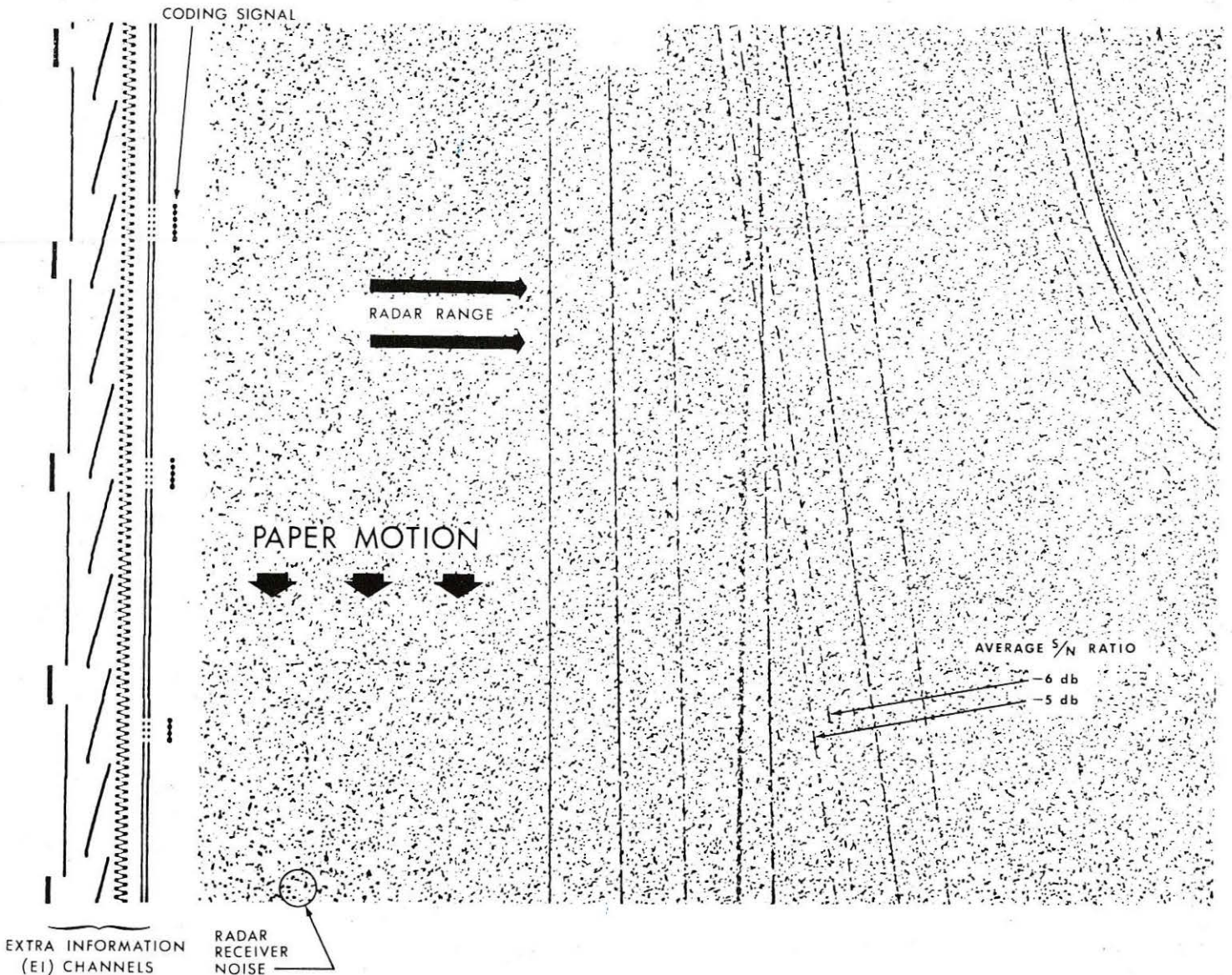

FIGURE 7: Expanded scale-film or paper speed versus data rate.

Some of the many other applications include: Spectrum analysis, ionospheric sounding, vibration, seismology, meteorology, telemetry, ASW, ELINT, COMINT, target detection and classification, frequency surveillance, sonar, and facsimile recording.

FIGURE 8: Reproduction of typical Intensigraph recording.



References

1. Skolnik, M. I., *Introduction to Radar Systems*, McGraw-Hill, pp. 441-443.
2. Tucker, D. G., "Detection of Pulse Signals in Noise: Trace-to-Trace Correlation in Visual Displays," *J. Brit. IRE*, Vol. 17, pp. 319-329, June 1957.
3. McGregor, P. M., "A Note on Trace-to-Trace Correlation in Visual Displays: Elementary Pattern Recognition," *J. Brit. IRE*, Vol. 15, pp. 329-331, June 1955.
4. Skolnik, M. I., and Tucker, D. G., "Discussion on Detection of Pulse Signals in Noise: Trace-to-Trace Correlation in Visual Displays," *J. Brit. IRE*, Vol. 17, pp. 705-706, December 1957.

A Computer Time-Shared Display

by Stephen B. Gray

The extraordinary utility of on-line computer usage by scientists, engineers, programmers and others has served to focus increasing attention on the man-machine interface. Computer output through display permits fast output in alphanumeric form and in graphs, diagrams, maps, etc. Also, use of a light pen permits the operator to input information to the computer directly through the display console.

Currently operating display systems, while accomplishing these well-known functions, suffer from several limitations. In producing a display, even a fairly large computer can be substantially tied up with the operation of a single console, continually looping through the same set of display instructions so as to regenerate the display repetitively and avoid flicker. This is a wasteful expenditure of computer time. Special-purpose hardware such as character and vector generators reduce computer usage considerably, but add to the cost of each console. To solve the problem of wasted computer time, several systems have been developed which utilize a buffer into which the display coordinates are written. These are then looped independently at the console station. This is also quite expensive, and restricts use of the light pen.

The display system described here has the following advantages:

1. Eliminates repeated loops of the display-generating instructions.
2. The display's frame rate is independent of the amount of material in the display.
3. Light pen data detection and writing can both be performed directly through the display console with very little computer time usage.
4. All of these advantages are provided at a cost-per-station considerably lower than that of currently available systems.

These results are realized through utilization of scan-conversion techniques. To clarify the process, it will be convenient to first describe the way in which a conventional display is generated, for example by a DEC PDP-1 computer utilizing a Type 30 CRT display. This is strictly a dot display, where the 10-bit coordinates of each point are sent individually from the computer. Display of each point takes 50 microseconds. Characters are made up on the average of 16 points. Clearly, not very many characters (or vectors) can be displayed with-

in the maximum no-flicker display period of 1/50 second.

The display system described here comprises a scan-conversion system with associated logic, amplifiers, etc.; a commercial high-resolution television monitor; and various logic circuits and computer interface elements.

The scan-conversion system utilizes a Raytheon QK685 one-gun recording storage tube. This tube is an electronic charge storage device consisting of an electron gun, a storage screen and a collector plate. The storage screen is a very fine-mesh metal screen coated on one side with a dielectric material. The electron gun provides an electron beam which can both store information on the screen by selectively discharging the dielectric surface with a modulated beam, and read the stored charge pattern on the screen by scanning it with an unmodulated beam. These are known as the write and read states^o, respectively. System operation may be understood with the aid of Figure 1.

After the storage screen has been erased and primed, it is ready to receive information. Successive coordinates of display points are fed from the computer to the Digital Display Generator. The output of its D-A converters are fed to the storage tube, and position its electron gun. After positioning, the electron beam is pulsed on, and a point is written. The system now awaits the next set of coordinates. After all of the material has been written the computer delivers a command which puts the scan converter in its "read" state. The computer is now freed from further concern with the display until the need arises to modify it. The actual display is generated as the electron gun scans the storage screen with an unmodulated beam current. This current will then be modulated as the storage screen is charged or discharged (permitting up to 7 gray levels). The modulated signal is passed (by way of the collector plate) to a readout amplifier. This video is sent to a standard 945-line commercial TV monitor, providing a continuous, flicker free display. This is known as the display data mode^o.

Another display system function which enables the console operator to single out a given element of the display with a light pen (hand-held light detector)

and thereby communicate with the program in the computer, is known as the "detect data mode." It operates as follows. Two counters are provided, X and Y. The Y counter is cleared by each successive vertical sync pulse (i.e., at the beginning of each field, where two fields interlace to provide one frame). The Y counter is then incremented by each horizontal sync pulse, providing for a resolution of approximately 450 in the vertical dimension. The X counter, in turn, is cleared by the vertical sync pulses, but also by the horizontal sync pulses. During each sweep of a horizontal line, the X counter is incremented by gating off a 2.83mc oscillator in such a manner as to provide a resolution of approximately 100 in the horizontal dimension. Thus, the X and Y counters contain relatively instantaneous information as to the position of the TV raster sweep at any given moment.

When the light pen is held in position on the TV monitor and enabled (via an operator-controlled micro-switch), it will be triggered by the first horizontal sweep to pass through its optical field (the light pen has a pick-up field of about five lines). To compensate for timing problems, a 35 microsecond delay (the duration of a single horizontal sweep and retrace) is initiated by triggering of the light pen, at the conclusion of which the next pulse from the raster generator is used to strobe the contents of the X and Y counters into a hold register. Triggering of the light pen is also used to set a program flag; thus the computer is informed that the operator has pointed at the display, and may interrogate the hold register at any subsequent time.

Another use of the pen is known as the "light pen writing" mode, by which the operator is permitted to draw new material on the face of the display, rather than simply detecting already-stored material. Its operation is as follows: The TV monitor is brought to a uniform level of brightness. The light pen is used as above. When triggered, it initiates a 35 microsecond delay but does not set a program flag. At the conclusion of the delay, a point is "written" on the storage screen. Actually the screen is not written but "primed," with the result that writing is "black on white" (black traces are left where the pen has been). This is a very natural condition for the operator.

When the operator has finished writing, the computer is so signalled, and

^o"State" refers to the operation of the storage tube. "Mode" refers to the operation of the overall display system.

readout of the storage screen is accomplished. The storage screen at this moment has been written at all points *except* at those locations where the operator caused it to become primed. If the electron beam is now projected (at low amplitude) on the storage screen, the output at the collector plate will be different as a function of the charge on the storage screen. In essence, the presence of a signal will be detected everywhere except at primed locations. The logic is so constructed that, when the electron beam is pulsed through a particular point on the screen, a program flag is set if a signal is detected. If no signal is present, the flag will not be set. Programming techniques then determine how the storage screen shall be read.

Under program control, a point is assumed to be written. A variable grey-scale chopper (actually an A-D converter) is provided, by means of which the desired signal-to-noise ratio may be set by the operator (or by the program). Reading the storage screen under program control, then may be accomplished by a raster scanning process by means of which an area of the screen is searched at a given density (every point, every

other point, etc.), or it may be considerably more sophisticated as the program operates according to various algorithms and performs an "intelligent" or selective search. In either event, the computer is able to retrieve from the storage screen the information recorded there by the console operator.

It is important to note that in both light pen applications, the computer is not required to maintain constant vigilance over the monitor. In both light pen "detection" and "writing" modes of operation, the critical and time-consuming operations are performed independently of the computer; the computer could actually be shut down during these periods. In a typical working system, we estimate that computer time per console should average no more than a few milliseconds per minute. Were character generators to be used in writing computer information onto the storage screen, this time would be further reduced by a factor of from 25 to 100 or more.

One limitation of this light-pen technique is that the operator cannot be shown digitally stored data while he is writing or drawing. This is not a serious drawback in most applications.

In a fully realized system, a large number of monitors will be accommodated

by a single scan converter. This is accomplished by transferring material from the storage screen to local video storage at individual consoles. The number of scan-converters which could be operated from a single computer would, of course, be a function of the size and speed of the computer. To the operator of an individual console, however, the sole feature which will distinguish the nature of the computer available to him will be the power of the programs under his control and the amount of stored material to which he will have access.

The resolution on the TV monitor is somewhat less than directly computer-controlled displays, but is adequate for all display applications but those involving very detailed drawings or tables. Of course, it is seldom necessary to fill the entire face of the CRT with text. Indeed, it would be impossible to do so without either introducing completely destructive flicker or utilizing a character generator. The TV monitor, on the other hand, is flicker free regardless of the amount of text displayed.

This system has been designed and implemented by Information International Inc., using a Digital Equipment Corp. PDP-1 computer, and components of their Type 30 Display.

FIGURE 1: Recording storage tube computer display.

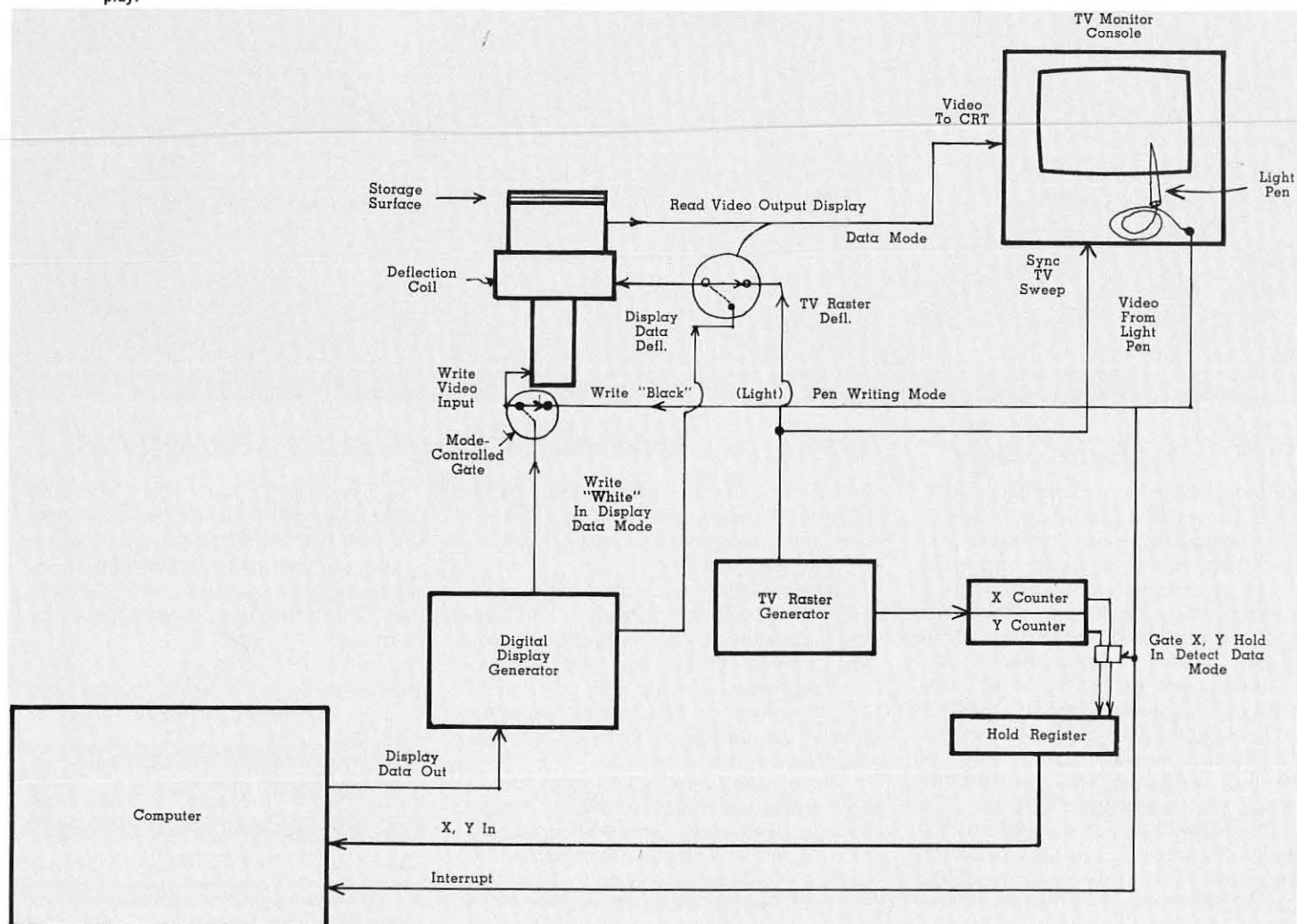

1,000,000,000,000

TRACE WIDTHS PER SECOND



Tube #	Screen Size	Feature	Focus	Deflection	Resolution	Trace-width	Fiber Dia. Microns
KC 2486P	8 ³ / ₈ " x 1 ¹ / ₈ "	Large presentation In-line scan tube	Electrostatic	Magnetic	200 li./in.	.005	15
K 2252P	2 ¹ / ₂ "	High-resolution, Electrostatic deflection	Electrostatic	Electrostatic	800 li./in.	.0012	10
KC 2287P	3"	Uniform-scan high resolution	Electrostatic	Magnetic	1500 li./in.	.0007	5
K 2226P	3"	High resolution	Magnetic	Magnetic	1000 li./in.	.001	8
KC 2474	12"	Direct plotting High brightness, contrast	Electrostatic	Electrostatic	100 li./in.	.01	50

Background above: Microphoto of fiber-optics bundle mosaic.

(and it's recordable — thanks to DuMont's Fiber-Optics Leadership!)

DuMont's leadership in fiber-optics technology has resulted in a whole family of CRTs having significant advantages over conventional means of display: up to 30 times more efficient presentation of spectral information, superior resolution and contrast, curved-field compensation, elimination of parallax, to name a few.

Take our new KC2427P, the 3", high-resolution CRT shown above (it's the CRT used in the world's first fiber-optics 'scope). In addition to one-shot writing speed of 10^{12} trace widths/sec, this new CRT has 1.0 mv/trace fs sensitivity (2.0 mv/trace sensitivity with a gain-of-8 amplifier), 500 lines/in resolution, 2.5 ns risetime at 100 mHz, a 1000-mHz band-width capability with unlimited scan rate, distributed de-

flected structure to capture broad-band transients, electrostatic focus and deflection, and a faceplate held within 1 mil of absolute flatness.

DuMont offers fiber-optics CRTs with a variety of options: Screens to 12" for large-screen presentation or for direct plotting or recording. You can have a choice of phosphors (including high-UV types) on aluminized or unaluminized screens, clad or unclad fibers ranging in diameter down to 4 microns.

For whatever application—high-speed, high-resolution direct recording, image coding, large-screen presentation, direct plotting, or direct coupling to other optical devices — DuMont is sure to have the right fiber-optics CRT for you.

Happy surprise—you'll find fiber-optics CRTs significantly smaller and less expensive than their conventional counterparts.

Write or call for informed applications assistance, or to ask for our new 1966 48-page Catalog listing over 4000 tubes that we make.

WORLD'S LEADING MANUFACTURER OF DISPLAY TUBES

FAIRCHILD

DUMONT ELECTRON TUBES
A DIVISION OF FAIRCHILD CAMERA AND INSTRUMENT CORPORATION
CLIFTON, N.J.

ID Authors

John S. Frost



John S. Frost received his BSEE from Columbia, and has taken graduate work at UCLA and San Diego State College. He engaged in circuit design in electrical systems for F9F-series aircraft (1949-53), and on design and test of aircraft electrical systems and cockpit instrumentation at General Dynamics San Diego (1953-62). In this period, he also engaged in instrumentation research. Since 1962, he has been Research Specialist with Autonetics Div. of North American Aviation. He is responsible for the design of experimental computer-generated displays.

Harold Klipper



Harold Klipper received his BSEE and MSEE from The City College of New York, and is presently engaged in graduate work at Polytechnic Institute of Brooklyn. He is presently Senior Project Engineer, Federal Scientific Corp., engaged in radar data recording and analysis. Prior to joining FSC, he was MCW Dept. Mgr. and Asst. Engrg. Div. Mgr., Polarad Electronics Corp. (1959-62); MCW Section Head, Polytechnic R&D Corp. (1957-59); and Project Engr., Polarad (1954-57). He is a member of Eta Kappa Nu, IEE, and a contributing author to *MCW Measurements Handbook*.

Stephen B. Gray



Stephen B. Gray obtained his BS/EE from the University of Pennsylvania ('56), then studied applied physics at Harvard University. In 1957, he joined Sylvania Electric Products where he was

engaged mainly in work at the Applied Research Laboratory until 1965, when he joined Information International, Inc. His recent interests have been in graphic I/O, especially character recognition and CR Tdisplays. The work described herein, concerning a time-shared computer display, was partly supported by the Advanced Research Projects Agency, DOD, under Contract SD-162.

Neil J. Arntz



Neil J. Arntz began his work in electronics in 1950 while employed as a technician in the U.S. Navy. He continued his work as a technician at The Boeing Co. while attending Seattle University, where he was awarded his BS/Physics ('58); he continued his formal education at the University of Washington. He entered management in 1962 and is currently assigned to product development design. He is coinventor of the "Hybrid Transport Delay System" and the "Three-Dimensional Hybrid Function Generators" currently in use at Boeing's Computing Laboratory.

AN IMPORTANT ANNOUNCEMENT ABOUT DISPLAYS FOR GE 425 USERS

Economical CRT Computer Controlled Displays, compatible with the GE 425, are now available from INFORMATION DISPLAYS, INC.

All solid-state (except for 21" rectangular CRT), these displays write up to 75,000 points or characters per second. Light pens, vector generators, size and intensity controls, buffer memories, and other equally useful options can be included.

One typical GE 425 compatible system is the IDI Type CM 10057. This unit operates with the GE 425 communication system and includes the CURVILINE® Character Generator, vector generator, mode control and light pen. The price of the CM 10057 Computer Controlled Display System is \$31,620.

Other combinations to meet each user's requirements can be assembled from the assortment of standard options.

Please write or call for complete information.

NOTE TO USERS OF OTHER COMPUTERS — IDI probably has delivered displays compatible with your computer . . . too!



INFORMATION DISPLAYS, INC.

102 E. SANDFORD BLVD. • MOUNT VERNON, N.Y. 10550 • 914 OWens 9-5515

ID Readout

AGARD Papers Call

Potential contributors to the Avionics Panel on **Displays for Command and Control**, Advisory Group for Aerospace Research and Development, in The Netherlands (tentative location), Sept. 1966, are invited to submit abstracts. Purpose of the meeting is to familiarize NATO scientists and engineers, both military and civilian, with the present state-of-the-art in data display, and to show potential users and designers how these displays can be integrated into command and control systems, by means of invited papers and discussion. A classified final paper would be considered, but the abstract must be unclassified.

Contributors should address abstracts, no later than February 28, 1966, to: Dr. I. J. Gabelman, Chief, Advanced Studies Group, Rome Air Development Center (EMD), Griffiss Air Force Base, New York 13442. A 300 (or more) word abstract of the proposed paper is desired. Papers will be chosen on the basis of these abstracts, and authors selected will be notified by March 15, 1966.

Late Notes and News

What has been termed one of the largest private exhibitions of computer systems and components ever staged in the United States was conducted recently in Washington D.C., sponsored by CONTROL DATA CORPORATION. Known as "A Walk-Around Seminar on Tools for Total Management," it displayed more than \$1 million in electronic equipment during the 4-day exhibit in the Exhibit Concourse of the Marriott Twin Bridges Motor Hotel. Attractions included a miniaturized computer system, visual data display systems, advanced disk storage drives, electronic data collection systems, magnetic tape certifiers, and other computer system components . . . INFORMATICS INC. has moved its headquarters to the firm's new Informatics Building, 5430 Van Nuys Blvd., Sherman Oaks, Calif., after outgrowing two former locations in two years . . . The ELECTRONIC TUBE DIV., SYLVANIA ELECTRIC PRODUCTS INC., has received four new contracts totaling more than \$181,000 for production of electron tubes for the military.

CALIFORNIA COMPUTER PRODUCTS INC., Anaheim, Calif., has concluded an agreement to acquire DATA-PLOT ASSOCIATES INC., a Maryland corporation, for an undisclosed stock consideration. As a wholly-owned subsidiary, Data-Plot will become area headquarters for sales, service and programming by CCPI, and will continue under the same management headed by Gregory M. Bell Jr., according to CCPI President Lester L. Kilpatrick.

Chapter News

LOS ANGELES CHAPTER: A dinner meeting at the Engineers' Club Oct. 27 featured a preview presentation by Petro (Pete) Vlahos. His topic — "The Three-Dimensional Display: Its Cues and Techniques" appeared in print in the Nov.-Dec. issue of ID. The talk proved to be a most original treatment of the subject and everyone left with a better appreciation of the problems facing not only the designer but also the user of the controversial 3-D display.

The last meeting for 1965 was held on Dec. 9th at the Courageous Rooster Restaurant. Following an Executive Council meeting where the spring symposium was considered, the dinner was served. The speaker of the evening was Dr. Robert O. Besco, Supervisor, Research and Design Group, Hughes Aircraft Company. His topic, "Information

Display in Attitude Control Systems" covered four formats of display for manual attitude control in a three-degree-of-freedom situation. Excellent use was made of visual aids including a movie clip of actual simulations.

NEW ENGLAND CHAPTER: Twenty-four members of *The Society for Information Display* have formed a New England Chapter. During the formative period, a substantial newsletter was begun to disseminate information about the group. During a complimentary dinner Oct. 13, National President James Redman addressed the group and expressed interest in having a New England Chapter join the organization. Pro tempore elections held at the dinner meeting saw selection of Glenn E. Whitham (*Information Display, Volume 2, No. 4, July/August 1965, pp. 15 and 32*) selected as Chairman; Ernest Agee, Vice Chairman; Harry H. Poole, Secretary; and submitted with the group's petition, and verbal approval has been transmitted. Since the October dinner, three Newsletters have been distributed, plans are under way for a Fall SID Symposium in Boston, and preparation of a comprehensive program for future meetings has begun. The first technical meeting featured Dr. Harrison Fuller, who spoke on an unusual thin-film matrix display technique. Carl Machover addressed the second meeting on "Commercially Oriented Graphic Displays." Future programs include a dinner meeting and tour of Project MAC at MIT (February), and a tour of the FAA facility in Nashua (May). The mailing list now contains names of 78 local SID members and 43 non-members. Address queries to: Harry Poole, Secretary, New England Chapter/SID, 38 Claudette Circle, Framingham, Mass.

AIAA Computer Subcommittee

The 40,000-member American Institute of Aeronautics and Astronautics has recently established a Technical Subcommittee on Computers. Its first chairman is Dr. Barry Boehm of The Rand Corp., Santa Monica, Calif. The purpose of the subcommittee is (1) to facilitate technical advances, and (2) reduce duplication of effort, by stimulating information transfer in the interface area between the aerospace sciences and the computer sciences. Proposed means to achieve these goals include:

- Compiling a catalog of aerospace computer programs
- Sponsoring sessions of technical papers on computer applications at AIAA meetings
- Coordinating with relevant professional organizations in the computer sciences, and
- Disseminating information on problems and progress in the computer sciences to aerospace scientists and vice versa.

Any suggestions on these or other possible useful activities will be welcomed by the subcommittee.

Dataplotter for Sonar Readout

The Navy's Underwater Sound Laboratory, New London, Conn., has undertaken a series of intensive studies of the ocean as a sound transmission medium. The masses of data obtained require computer processing and conversion to usable graphic form. For the display, an Electronic Associates Inc., West Long Branch, N.J., Dataplotter is used. Signal energy received from known sound sources is recorded in analog form on a 14-channel magnetic tape recorder, and subsequently converted into a digital tape. A digital computer then analyzes the data and produces an output magnetic tape which drives the EAI 3440 Dataplotter, providing a graphic display. Typical is a representation of energy drop-off vs. time. Scientists and engineers making the analyses take into account such variables as salinity, sea state, ocean bottom contours, and content and water temperature, all of which affect transmitting efficiency.

Opportunities for

Design & Development Engineers in Electronic Signal Processing and Display Systems

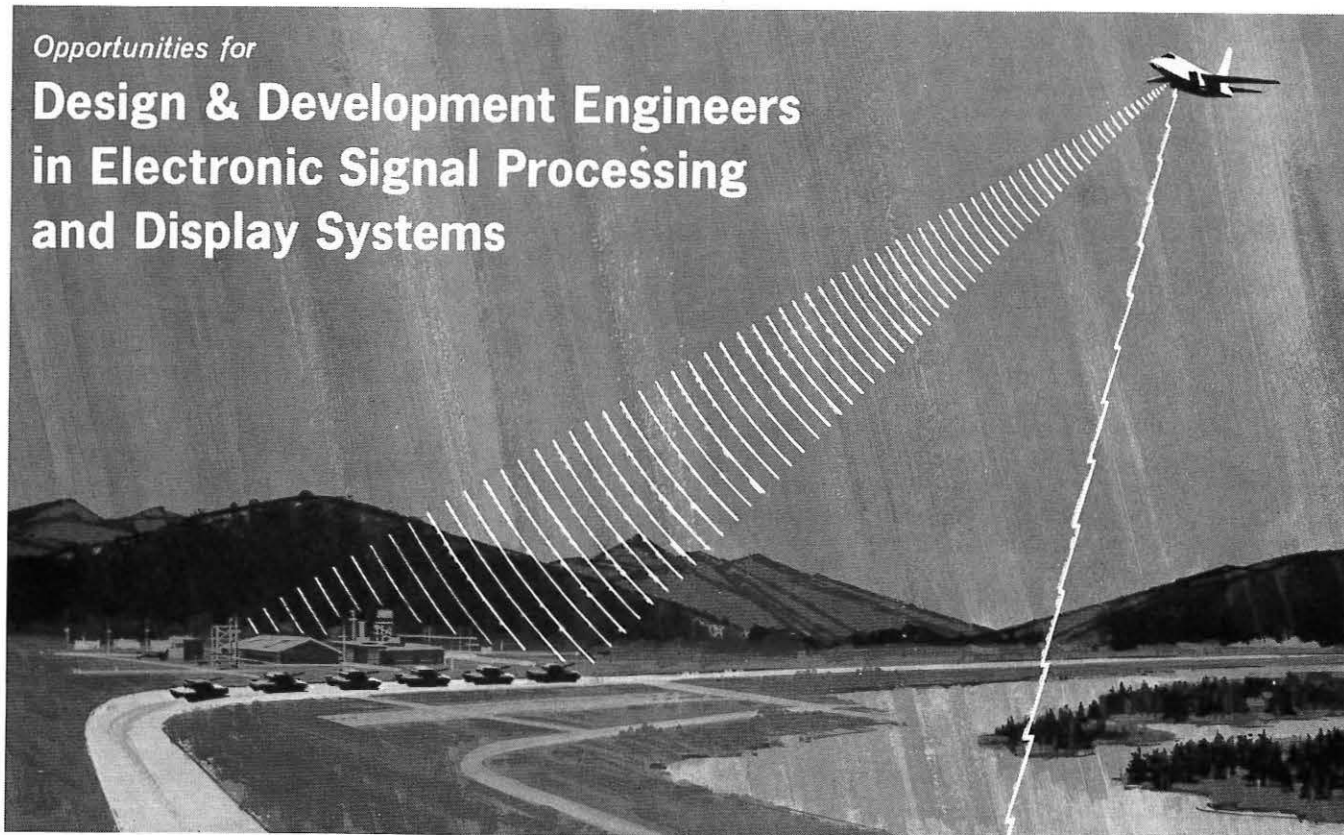

Design and Development activities in the field of Electronic Signal Processing and Display are rapidly expanding today at HUGHES Aerospace Divisions.

Advanced development is being accelerated on **high resolution pulse doppler radars** and other sensors utilizing matched filter, synthetic array, pattern recognition and other exotic correlation techniques.

Specialists will be interested in the many challenges and rewarding assignments now available in Project Engineering, Radar System Design, Performance Analysis, Signal Processing with emphasis on synthetic array, Information Display, System Simulation and Human Factors; in Circuit, Mechanical and Packaging Design.

Stimulating assignments are immediately available for graduate Engineers with accredited degrees and several years of applicable, professional experience in one or more of the following areas:

1. Highspeed Timing & Sampling Circuits
2. Optical & Electronic Moving Maps
3. Ultrahigh Speed Film Development
4. Wideband Video & IF Amplifiers
5. Mixers & Balanced Modulators
6. High Precision CRT Circuitry
7. Scan Converters Storage Tubes
8. Aerospace System Simulation
9. Multisensor Data Display
10. Precision Film Transport

All interested persons are invited to submit resumes in confidence.

For immediate consideration please write:

Mr. Robert A. Martin
Head of Employment
HUGHES Aerospace Divisions
11940 W. Jefferson Blvd.
Culver City 68 Calif.

Creating a new world with electronics

HUGHES

HUGHES AIRCRAFT COMPANY
AEROSPACE DIVISIONS

An equal opportunity employer

U. S. CITIZENSHIP REQUIRED

ENGINEERING OPPORTUNITIES

Exciting opportunities have developed at Ampex for creative engineers who will make significant contributions to our new VIDEOfILE systems, which use video tape for the storage and retrieval of documents in large file systems. Typical of our openings are these:



Ampex engineer observing Videofile System as applied to storing, retrieving and displaying scientific data.

Logic Design:

State-of-the-art circuits in computer equipment and systems for document storage and retrieval.

Circuit Design:

Video circuits, distribution amplifiers or VHF circuits. Knowledge of electron optics desirable.

Applications Analysis:

Develop new market applications for Videofile systems, and evaluate and translate customer inquiries into new systems. Must have commercial company background, thorough exposure to computer technology and office system methods.

These positions represent opportunities to move into greater responsibility, and you will find our compensation and benefits plans as progressive as our products!

**C. R. Moody, Employment Manager, AMPEX CORPORATION
401 Broadway, Redwood City, California 94063**

AMPEX

An equal opportunity employer.

Electrostatic Alphanumeric Storage Converter

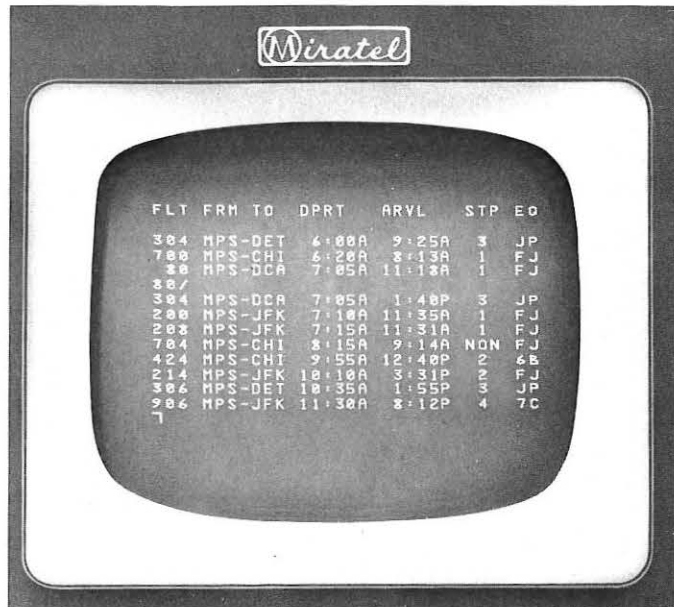

Miratel Electronics Inc., St. Paul, Minn., has developed an electrostatic storage converter for alphanumeric applications. The device permits writing and storing of digital or character-generator numbers direct from a computer, with the playback viewed in real time as a standard 525-line real time TV display. Input can range from slow-scan to high-resolution 1000-lines TV rates. The device can also be used to transfer random-access tape page storage to magnetic drum or disk frame storage through its ability to freeze time and synchronize to the recording medium. Write, read, and rewrite functions are sequential. Information once written can be read immediately or after several hours. Nominal storage time before rewrite is 5 minutes, but can be extended to 10-minutes-plus. The restore or erase function requires an amount of time approximately equal to the write mode. A single TV field or TV line (63 microsecs.) can be easily recorded, yet one-shot techniques permitting the recording of a full TV frame and immediate playback present no difficulty. Except for the electrostatic storage tube, the set is fully transistorized (fewer than 75 transistors). Design is primarily to provide an intermediate step where CRT alphanumeric displays are used.

High-Resolution 5.75-lb. CRT Assembly

Philco's Aeronutronic Div., Newport Beach, Calif., has announced production of a high-resolution 5.75-lb. CRT assembly which features a 0.5-mil spot size over a 2.75-in. diam. quality circle. It is designed for airborne recording of aerial photographs — both line and frame scan — and other applications similarly requiring high-resolution with small size and low weight. The 3-in. CRT (4XP-11) was developed by Philco's Lansdale, Pa., div. as part of the center's high-resolution side-looking Army radar programs. The sets use two CRT assemblies to record by line scan high-resolution radar information, producing photographic quality terrain images. They meet MIL specs for airborne equipment. The assembly includes CRT magnetic deflection and focus yokes, and magnetic shield and support casting. "Considerable" size and weight savings are reported through use of low capacitance for the video driver, absence of normal G_2 and G_3 voltages, and low voltage requirements for dynamic focus. Special-purpose recorders have also been developed, which make use of the small CRT. Also available are circuit designs and lightweight 10kv power supplies to meet a variety of sweep-frequency and scanning formats. Optical and film-handling systems — including rapid film processing and display features — may be incorporated as needed.

INFORMATION DISPLAY, JANUARY/FEBRUARY, 1966

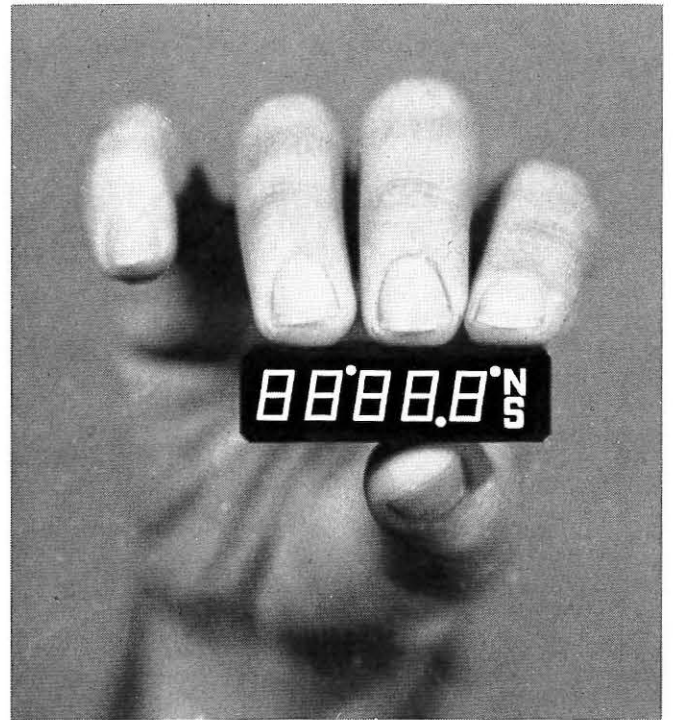

New brilliance and clarity in a digital read-out!

More than a dozen outstanding features demonstrate that the Tung-Sol DT1511 is the most thoroughly engineered read-out of its type. Its physical and electrical characteristics combine to produce a read-out of unequalled legibility. DT1511 provides all those features most desired for brilliant display, thorough reliability and universal application.

Write for bulletin T430 which contains detailed information. Tung-Sol Electric Inc., Newark, N.J. 07104.



Brilliance. Incandescent lamps provide clear, white characters with a minimum brilliance of 500 foot-lamberts at 4.0 volts.



Wide angle view. Characters lose none of their legibility even when viewed at an angle of 150 degrees.

In-line, in-plane. Viewing surface is a single, integrated block with characters precisely aligned in the same plane.

Clarity. Seven-segmented characters have high contrast between "on" and "off" segments, resulting in unequalled clarity.



CENTER LINE
QUALITY

TUNG-SOL DT1511
ILLUMINATED DIGITAL DISPLAY

Circle Reader Service Card No. 26



NOW, a low-cost, self-decoding readout with uniform brightness

Performance Plus Economy. Simplified optical system provides brighter, more readable display with perfect uniformity between characters.

Self-Decoding. Decoding is inherent in the design. No additional electronics required.

Long Lamp Life. Lamp is constantly lit. Lamp life is not decreased by switching on and off.

Simplified Maintenance. One lamp to replace— one lens system. This means less down time for expensive equipment.

Lower Cost. Straightforward design saves you money in purchase cost, maintenance and down time.

Width 1-9/16", Height 2 1/8", Length 5 1/2", Digit Size 1", Weight 10 oz. 6 or 12 volt lamp; Circuit 20 volt Standard. Other voltages available.

Write for literature and prices



5806 West 36th St., Minneapolis, Minnesota 55416. Phone 929-1681

Circle Reader Service Card No. 27

Video Color Corporation Industrial Tube Division

offers

TECHNICAL ABILITY

For any special purpose Cathode Ray Tubes

ULTRAHIGH RESOLUTION

(Less than .0005" spot size)

FIBER OPTIC FACES

HIGH CONTRAST

Special Ultrathin glass substrates to eliminate halation

SPECIAL SCREENS

Any Phosphor
High uniformity, Ultra Smooth Texture
Low Screen Noise
High Light Output

SPECIAL ELECTRON OPTICS

High Deflection Sensitivity
High Beam Currents
Multiguns
High Voltage

SPECIAL GEOMETRIES

Back Ported Tubes
Special Deflection Angles

SPECIAL GLASS STRUCTURES

Internal Targets

FULL LINE OF STANDARD TYPES

CRT's FOR —

Character Generators (Monoscopes, etc.), Readouts, Printers, Oscilloscopes, Radar, Monitors, Video Recorders, View Finders, Flying Spot Scanners, Back Ported Devices, etc.

Video Color Corporation



729 Centinela Avenue Inglewood, California

Phone: 213-678-8192

90302

Circle Reader Service Card No. 28

Load Monitor Console

Gap Instrument Corp., Westbury, N.Y., has announced a load monitor digital display console which serves as a read-out source of computer information and in interrogation medium for desired computer information. It was designed and built under a contract with NASA/Huntsville. In addition to presenting a 4-digit information display for any of 10 channels, the console is equipped with callouts for sign selection, scale designation, range indicator, selector switches, master control status indicators, and, for transmission of information to the computer, thumb-wheel BCD switches. Communication between the console and the main computer interface is by means of 4-line BCD input, which is correlated into the desired panel position by single line selection. Information is transferred upon command of a computer strobe signal. The system has associated with each digit a decoder/memory printed-circuit card, which has the ability to memorize computer information within a few micro-seconds. It is designed to work with negative going logic at -12 v and incorporates decimal point display with leading zero suppression. Information display is achieved through a Series 13 Microphysics plug-in DiGiCATOR, which features adjustable brightness through front panel control, single plane display and readability over 170°.

Nationwide CRT-Display System for UAL

United Air Lines has commissioned Univac Div. of Sperry Rand Corp. to design and build an on-line computerized information system representing an investment of \$56 million. It will be the largest in the business world and the first to utilize cathode ray tube input/output devices on a nationwide basis, according to UAL. The system will provide totally integrated reservations, operations and management information capability. Of the total cost, \$39 million is for electronic equipment and computers, and the balance for leased transmission lines over a 5-year period, plus new facilities for installation. It is scheduled to be operational early in 1968, and is designed to handle UAL passenger and fleet volumes through 1975.

ID Tutorial Session

A one-day tutorial session on information display R&D is scheduled for March 31, 1966 in Santa Monica, Calif. This one-day seminar is being hosted by the Los Angeles Chapter for the entire SID membership. Registration begins at 8:30 a.m., followed by the annual SID business meeting and installation of the new national officers. There will be a luncheon speaker, several technical papers and a panel discussion concluding at 5:00 p.m.

Light Valve and Laser Display Firsts

A recent bulletin of the Air Force Laboratories' Research and Technology Division reports two "firsts" achieved in approaches to large-scale displays: "For the first time anywhere, feasibility models of a solid-state light valve and a laser display were used to project TV images for large-scale viewing. The solid-state light valve is basically similar to a film projector. The difference is this: The film is replaced by an electro-optic crystalline material that can be modulated and scanned by an electron beam to create an electrostatic charge pattern. This pattern is impressed on the surface of the crystal, resulting in an optical image. This image, in turn, can be projected onto a screen for large scale viewing. The laser display utilizes a laser beam, in much the same manner that an electron beam is used on a cathode-ray tube, to provide an image. The advantage of this development is that the laser beam can be scanned, modulated, and projected outside of a vacuum." [See *Information Display*, Vol. 2 No. 2/March-April 1965, pge. 18, "Solid-State Light Valve Study," by J. Calucci. — Ed.]

INFORMATION DISPLAY, JANUARY/FEBRUARY, 1966

Transistor-Controlled Readouts

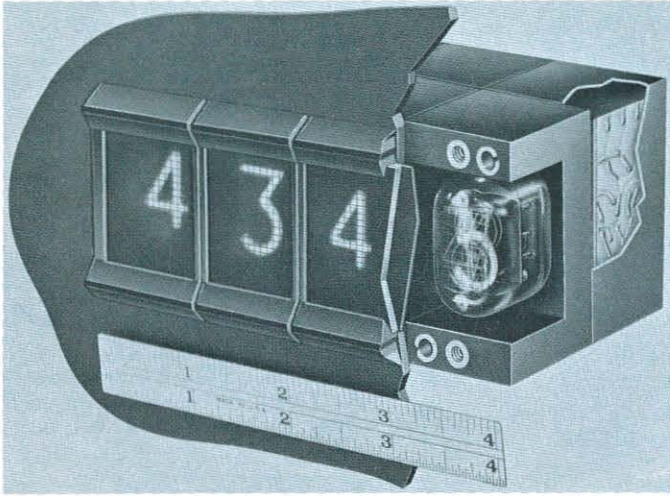

A new M-Series of transistor-controlled readouts, by Transistor Electronics Corp., Minneapolis, Minn., are designed to operate directly from the output signal levels of many integrated circuit packages currently available to designers. Input impedances of the Tec-Lite M Series are specified to allow calculation of fan-out and fan-in according to the integrated circuit manufacturer's specifications. They are available in three series, and handle 8-wire or 4-wire B.C.D. input. The MTNR-10 series has four models; MTNR-20 and MTNR-30 each have eight models. Elements of the rectangular neon readout tube are controlled by internal all-transistor decoder-driven circuitry that eliminates diode decoders and reportedly reduces the number of semi-conductor components by 60%. All tube elements may be turned off when no indication is required. The readout utilizes rectangular, ultra-long life Nixie tube with a flat face which brings numerals closer to the front for excellent wide-angle viewing. Numerals are .610 high.

Automatic Aircraft-Drafting System Installed

An automatic drafting system — capable of preparing aircraft drawings from mathematical data and also able to convert drawn sketches into coordinate information — has been delivered to General Dynamics Ft. Worth, according to an announcement by Alfred L. Rifkin, vice president of marketing for The Gerber Scientific Instrument Co. According to a General Dynamics statement, the Gerber Series 1075 system is "one of the industry's largest, most versatile numerically controlled graphic display systems." The system will be used for construction of basic lines from mathematical formulae, and preparation of scaled preliminary design drawings from a mathematical description of surfaces and programmed sketches. It will also prepare master layouts for use in actual fabrication of aircraft parts, and to determine basic performance parameters.

The graphic display system is composed of a Gerber Series 1000 control to provide fast, accurate input data processing, computation, and drawing table positioning commands. The Model 75 table is capable of making precise drawings up to 5 ft. x 16 ft. and can draw lines at speeds up to 200 in./min. Accuracy is $\pm .005$ in. overall. The converse function of converting drawings, sketches, etc., into mathematical form is performed by a digitizing accessory which employs a closed-circuit TV camera to position the reader over graphic coordinates. The system also provides a core-memory symbol-generator; scaling, which enables infinitely variable drawing size from 0 to 10 times with a different scale for each axis; and the capability of accepting input tapes from a variety of other control devices without post-processing or data re-formatting.

NEW!

LITTON SOLID-STATE DEFLECTION AMPLIFIER

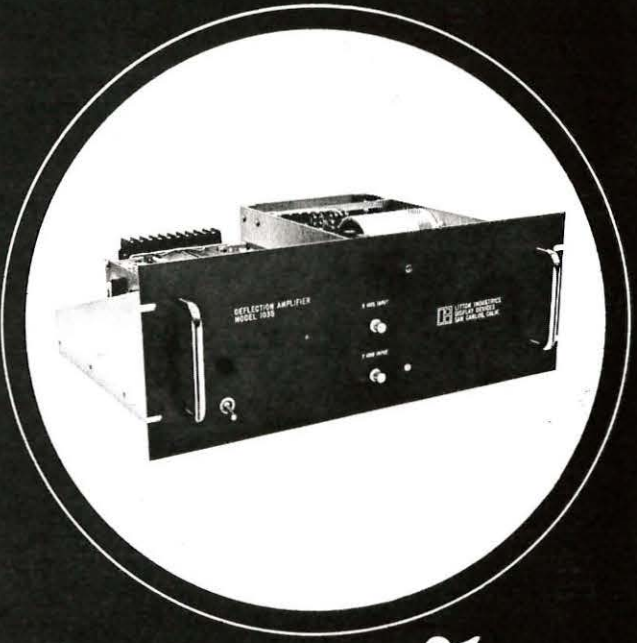

0.04%

DYNAMIC LINEARITY

Unprecedented linearity for flying spot scanners, recorders and display systems is offered by the Litton Model 1035 Deflection Amplifier. This extremely stable, two-axis deflection yoke driver makes very high energy available to the yoke and performs ultra-linear voltage/current conversion. Voltage "in" to current "out" dc linearity through a cathode ray tube deflection yoke is 0.04%. Output current through yoke is conservatively rated at 12 amperes, peak to peak. Sawtooth retrace time capability is 9 microseconds through 40° at 25 kv with a 25 microhenry yoke. Amplifier and regulated dc supply are mounted in a standard 19-inch rack panel. Dimensions are 7 inches high by 19 inches wide by 14 inches deep. The Model 1035 is the latest in the Litton line of deflection yoke drivers for advanced laboratory and airborne applications. For details on deflection amplifiers or for information on our complete line of display devices and associated electronic equipment, write San Carlos, Calif., or telephone (415) LYtell 1-8411.

LITTON INDUSTRIES ELECTRON TUBE DIVISION

San Carlos, California / Canada: 25 Cityview Drive,
Rexdale, Ontario / Europe: Box 110, Zurich 50, Switzerland

on the move

Inca Engineering Corp. has announced the appointment of **Rafn Stefansson** as programs mgr. for Electro-Optical Technology.

Sperry Rand Corp.'s Sperry Gyroscope Co. Div. has named VP **Percy Halpert** to manage its inertial, information & communications, radiation, and support services operations.

Elliott Berman has been named to the newly-created post of Director at Itek's Lexington Research Laboratories. Itek has also appointed **J. David Hopkins Jr.** VP/Commercial Activities, and **Neil P. Yingling** as programs mgr. of its Graphic Processing Div.

Raytheon Co. has appointed **Richard D. Knowles** Western Regional mgr. at Hawthorne, Calif., and **Paul R. Keeler** Northeast regional mgr. at Waltham, Mass.

The Bunker-Ramo Corp. has elected **Edward Shippen** treas. of the firm, and **C. Raymond Smith** has been elected Exec. VP and a director.

Frederik H. Lutter has been appointed VP of Bankers Data Corp., in charge of the firm's new Data System Services Div. Scientific Data Systems has named

Emil R. Borgers, Dan L. McGurk, and Robert P. Adams as VPs of the Santa Monica, Calif. based firm.

Byron L. Fry has been named dir., mgt. systems and computing sciences dept., Atomics Intl. Div., North American Aviation.

Stanley H. Cochran has joined Planning Research Corp. as Western mktg. mgr.

S. J. Jatras has been named pres. of Midwestern Instruments, and **Roger M. Wheeler** has been elected board chairman of the parent Telex Corp.

Mark Systems Inc. has appointed **Saul P. Levine** mgr. of mil. and space prods, according to **Bernard P. Marcus**, pres.

John Rennels has been appointed acting sls. mgr. of Litton's Clifton Precision Products Div., replacing VP **Thomas W. Shoop**, resigned, according to **James Weidenman**, the division's chief exec. officer.

Vincent S. LaRosa has been named to the board of Instrument Systems Corp., according to **Helmuth W. Waldorf**, chairman.

John Craver has joined Hobbs Associates Inc., Corona Del Mar, Calif., digital specialists, as senior consultant.

Gen. Bruce C. Clarke (USA-Ret.) has joined The Bunker-Ramo Corp. as a consultant for command and control on major defense programs, within the Defense Systems Div.

Peter Seats is now pres. of Thomas Electronics Inc., Passaic, N.J. Former pres. **Eugene Ecklund** is no longer associated with the firm.

Joseph E. Woodward has been promoted to dept head, aviation systems research, Airborne Instruments Laboratory Div. of Cutler-Hammer.

George W. Brown, Prof. of Business Admin. and Engrg., UCLA, has been elected a director of Informatics Inc.

M. E. Johnson has been appointed international mktg. mgr. for Northrop Corp. Nortronics Div.

Thomas J. Nicholson has joined MVR Corp. (formerly Machtronics Inc.) as VP, according to **Kurt R. Machein**, pres.

Computer Applications Inc., has named **Howard L. Waltman** a member of the mktg. staff at New York.

(Continued on page 69)

LIGHT MEASUREMENT PROBLEMS?

 **CHECK GAMMA SCIENTIFIC**

Specializing in instruments and systems for light measurement, Gamma Scientific combines experience, innovation and craftsmanship in its broad line of products, including:

Photomultiplier Photometers • Calibrated Light Sources • Telephotometers • Photometric Microscopes • Complete Accessories.

For the latest catalog contact: Sales Manager, Dept. 223, Gamma Scientific, Inc., 5841 Mission Gorge Road, San Diego, Calif. 92120. Specific problems? Call collect 714-282-2178.



GAMMA SCIENTIFIC, INC.

Circle Reader Service Card No. 30

NOW IN PRODUCTION

MATRISWITCH ILLUMINATED PUSH BUTTON SWITCH

Available with connector assemblies, the new Jay-El Matriswitch Illuminated Pushbutton Switch allows compact arrangements in limited space. Meets requirements of Mil-S-22885A. Available now.

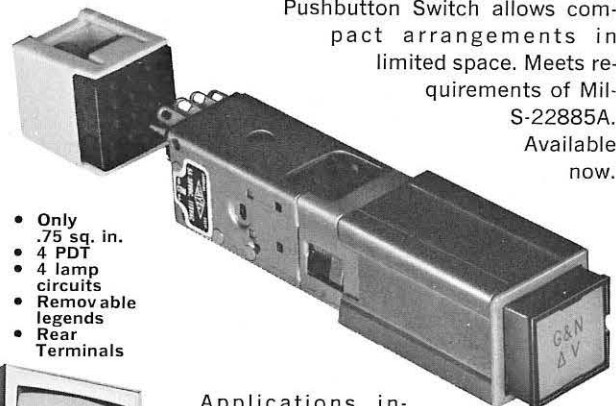

- Only .75 sq. in.
- 4 PDT
- 4 lamp circuits
- Removable legends
- Rear Terminals



Applications include F-111, C-141, Snap-8, computer consoles, ground support equipment, commercial and industrial and military applications.

Write for full technical information

JAY-EL PRODUCTS, INC.

1859 W. 169th ST., GARDENA, CALIF. 90247

Circle Reader Service Card No. 31

INFORMATION DISPLAY, JANUARY/FEBRUARY, 1966

ID Correspondence

Rods & Cones Cooperative?

This letter was prompted by the fine article by R. L. Kuehn "Color Vision" in the Sept./Oct. issue of *Information Display*.

Just about everybody and his brother has a theory of color vision; yet, as the author points out on page 52: "... no theory exists today which is a completely satisfactory hypothesis for all color vision phenomena." Perhaps the reason for this is that a wrong turn was taken somewhere in the past.

For example, one bit of reasoning that can be found in the literature goes something like this:

Since scotopic vision is colorless, then the rods can play no role in color vision.

The reasoning continues then to develop the requirement for the existence of at least three distinct types of cones.

This line of reasoning completely ignores the possibility that both rods and cones are necessary for color, and that perhaps the normal statistical variations in rods and in cones might be sufficient to take over the role of a third type of sensor.

We at OEI have taken the following approach to the problem of color vision:

- (1) Take what is known concerning the physiological structure of the retina,
- (2) Determine what color information can be obtained by use of this known structure,
- (3) Extend this reasoning cautiously to other areas of color vision by a minimum of speculation concerning unknown aspects of the structure, testing as we proceed.

We have discovered some interesting relationships by use of this approach. One basic ingredient of our approach is to allow the possibility that *rods and cones* operate in photopic vision in a *cooperative mode* to help furnish color information. This approach has been quite promising to date.

(There will be those who will object, saying that experiments have shown that color is sensed without rod vision. On the other hand, there have been other experiments showing that this is not true. The nature of all such experiments is such that no conclusion can reliably be drawn pro or con, in our estimation.)

I will indicate in the following paragraphs just one instance where some inspired data reduction appears to have opened a door.

First we obtained the (logarithmic) photo-chromatic interval. This can be obtained from readily available C.I.E. data or data from other sources. (The pci is the difference between the logarithm

of the spectral response functions for rods and cones, as a function of wavelength.) For the observer with normal color vision, the pci is a monotonic function of wavelength.

Inspiration: Perhaps the pci is related to *hue* as sensed by a person with color vision. It does satisfy certain basic requirements for such a function. (1) It is monotonic, thereby precluding hue anomalies. (2) Its slope approaches zero at both extremes of the visible spectrum, indicating limits on the hue-discriminating capabilities of the observer.

There is another little data reduction exercise that can be performed to test this further, as given below.

Curves exist in the literature giving delta lambda vs lambda, where delta lambda is the change in wavelength of a pure spectral line required to produce a just-noticeable-difference in hue. This curve must logically be related to the pci curve by the relationship

Delta lambda = (slope of pci function)⁻¹
Some reflection will convince the reader that this must be so.

We tested a few delta lambda curves appearing in the literature against pci curves, after being transformed accord-

ing to the above relationship. The agreement is too startling to be merely coincidental.

In a letter it is of course impossible to fully argue a case of this type. But the one example of a simple test anyone can perform given above leads to the following speculations and implications:

- (1) Rods and cones cooperate in collecting hue information.
- (2) Normal statistical variations in sensor curves may provide saturation (color purity) information.
- (3) Brightness information presents no particular problem, being in the nature of a summated sensor output.
- (4) Persons having anomalous hue responses should be expected to have abnormal sensor response functions. Experiments support this.
- (5) Pure rod or pure cone vision should be colorless.

At OEI we have accumulated more evidence for the validity of this approach than can be indicated here. We are enthusiastic about the possibilities, and are continuing work in this area.

Sincerely,
HOMER B. TILTON
Vice President
Optical Electronics Inc.
P.O. Box 11140
Tucson, Ariz.

MAGNETIC SHIELDING MADE EASY

APPLIED IN SECONDS

Cut to any size or outline
with ordinary scissors



Co-Netic and Netic foils are ideal for initial laboratory or experimental evaluation... also for production applications and automated operations. Dramatically enhance component performance by stopping degradation from unpredictable magnetic fields. When grounded, foils also shield electrostatically. They are not significantly affected by dropping, vibration or shock, and do not require periodic annealing. Available in thicknesses from .002" in rolls 4", 15", and 19-3/8" wide. High attenuation to weight ratio possibilities. Every satellite and virtually all guidance devices increase reliability with Netic and Co-Netic alloys, saving valuable space, weight, time, and money.



MAGNETIC SHIELD DIVISION

Perfection Mica Company

1322 N. ELSTON AVENUE, CHICAGO 22, ILLINOIS

ORIGINATORS OF PERMANENTLY EFFECTIVE NETIC CO-NETIC MAGNETIC SHIELDING

Bidirectional Counter

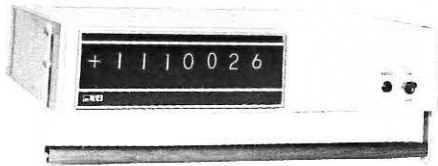

The Model 658 is a new 500 kc all-silicon bidirectional counter just announced by Janus Control Corp., Newton, Mass. This instrument counts in both directions at 500 kc, and reverses without error at this maximum rate. In-line display is provided for convenient wide angle viewing. Model 658 operates directly from 2 input signals in quadrature with input levels as low as 100 mv peak.

The instrument may be used with machine tool control systems, process control systems, guidance systems or any application requiring the comparison of two input signals such as shaft encoder outputs, accumulation of pulses from one or two sources, and the addition or subtraction of random input pulses. It is 3½" high x 14" deep x 17" wide, and many options are available.

Circle Reader Service Card No. 33

256-Slide R-A Projector

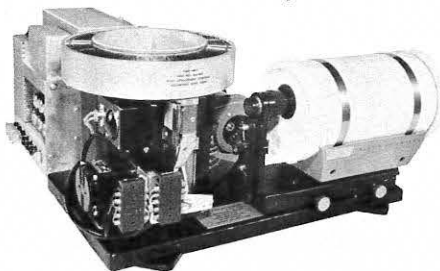

Mast Development Co., Davenport, Ia., has announced a Random-Access 256-slide projector with which slides or overlays can be projected at random into a closed-circuit TV system in 3.1 seconds average time after a request. Projection can be forward or reverse sequence at 1-sec. intervals; no slide is more than 5.2 secs. away from any starting position. Slide requests can be made with rotary or pushbutton switches, or by computer command through a "buffer."

Slides of near-real-time or stored data can be rapidly selected at random, projected into a closed-circuit TV system, and overlaid electronically onto CRT images.

Circle Reader Service Card No. 34

50-Channel Graph Display

Metra Instruments, Redwood City, Calif., has announced a "Metrascope" a new multi-channel bar graph display capable of handling 50 input channels having full-scale signals as low as 8 mv or as high as 10v dc.

According to the manufacturer, the principal features include a solid-state scanner with a minimum sampling rate of 30 samples/channel/sec., 19-inch cathode ray display tube; an electronically-generated calibrated grid; and high and/or low alarms. Additional features include alarm annunciation by brightening of the individual databar display and by relay closure; means for digitally reading signal levels; fifth-channel

ID Products

brightening for rapid channel identification; thermocouple cold junction reference when required; front access to all components; and quick disconnect chassis and plug-in components for ease of maintenance.

Circle Reader Service Card No. 35

Xenon Projection Bulbs



The Osram Xenon bulb has been engineered to provide the ultimate in arc stability, assuring steady screen brightness and sharp definition, the manufacturer states. They are available in 250, 500, 1000, 2000, 3000, and 5000 watts. Color quality, resembling that of natural daylight at an approximate color temperature of 6000°K, is free from deviation even with a variation of input power throughout the rated life. The bulb features compactness, long life, steady arc, and low cost-per-hour of operation. Details and prices are available from Macbeth Sales Corp., Newburgh, N.Y.

Circle Reader Service Card No. 36

RFI-Shielded Lamps



Control Switch Div., Controls Company of America, Folcroft, Pa., has added subminiature indicator lights to its line of RFI-shielded front-of-panel components. The entire line, which already includes standard indicator lights and pushbuttons, utilizes internal grounding and bonding to suppress RFI conduction and radiation.

In the new lights, RFI is absorbed by a mesh shield within the plastic indicator lens. A special conductive seal connects the

shield to the indicator case, which in turn provides a low-impedance RF path to ground. This combination effectively eliminates RFI radiation in the important 0.15 to 1000 mc range, the manufacturer claims. The lights measure only 9/16-in. overall and weigh less than 0.032 oz.

Circle Reader Service Card No. 37

High-Energy Flashtube

Xenon Corp., Watertown, Mass., has announced a new pre-fired C6.5-103 linear flashtube. It is designed for high-energy laser pumping, and has a 10,000 Joules/pulse input capability on only 6.5 in. of arc length. Spectral characteristics approximate natural sunlight, covering the visible range and extending into both uv and ir.

The firm's 7/16-in.-diam. solid, OFHC copper electrode feedthroughs extend to the tube exterior for more efficient heat dissipation. Other features include unusual electrode design, resistance to thermal-electrical-mechanical shock, large area and cap construction, and a high metal-to-quartz ratio.

Circle Reader Service Card No. 38

New Submin Lamp Line

Industrial Electronic Engineers Inc., Van Nuys, Calif., announces the introduction of its own line of subminiature incandescent lamps: T1, T1-¼ and T1-⅛. Although these are the three basic sizes now being offered, IEE is equipped to provide special configurations to meet unique applications.

Advantages claimed include: An extra-long aging process which assures stability and reliability; individual selection of each lamp based on a light meter test of its mean spherical candle power to assure light quantities that meet design specifications; specially blown bulbs designed to provide greater accuracy, eliminate distortion, spots and to ensure near-perfect centering of filaments. In addition to inspection of basic materials, regular production line checks and the individual selection of each unit, these new IEE subminiature lamps are again tested before they are shipped to a customer.

Circle Reader Service Card No. 39

500-Ft-Lambert Readout

Tung-Sol Electric Inc., Newark, N.J., provides a new line of digital readouts which the firm states give clear white characters with minimum brilliance of 500 Ft.-Lamberts. This is accomplished through use of ultraminiature high-intensity incandescent lamps, combined with design utilizing "light-pipe" segments which minimize brilliance loss. The standard character is composed of seven segmented bars capable of displaying 20 standard signs, the 10 numerals and letters A, C, E, F, G, H, J, L, P, and U, with provision for decimal or degree sign after each digit. Special characters can be added.

Features include adjustable brilliance, wide viewing angle, in-plane in-line display, low-voltage operation, and simple maintenance. Character size is 0.32 in. high and 0.19 in. wide; overall assembly is 0.625 in. high, 0.313 in./digit plus 0.187 in. width, and 1.578-in. depth. Power requirements are 4 v ac/dc, 0.070 amp/lamp.

Circle Reader Service Card No. 40

INFORMATION DISPLAY, JANUARY/FEBRUARY, 1966

陷。機員八人均為預備軍官
 魯空軍某。飛機於火起後
 落於。南五里之海面
 高中。機。艇逃出獲
 度頓軍營。醫院。
 於拯救。進行
 機螺旋槳。又生
 機師則仍設法留
 下海。式人隨由壹
 救起。

青年跳金門橋

金門橋前日晨。發生壹

橋自殺案。相信已跳橋自殺
 年式十式歲。據報于晨十
 越橋欄而跳下海。惟其父親



$$\int_{\omega/2}^{2\pi - (\omega/2)}$$

$$2L \int_{-\pi/2}^{(\pi/2)} \frac{\cos^2 \eta}{\pi} d\eta \int_{0, \pi}^{(\nu/2) - (\omega/4), (\nu/2) + (\omega/4)}$$

$$\frac{\sin^2(\nu)}{\sin} \int_{0, \pi}^{(\nu/2) - (\omega/4), (\nu/2) + (\omega/4)} \frac{\nu \sin 2\mu}{2} \cos \frac{\nu}{2}$$

6.9200	-3.9900	4.0867	4.0775	4.0699	4.0543	10.66110
6.9200	-3.9900	4.3916	4.3900	4.3896	4.3932	11.24929
6.9200	-3.9900	4.7433	4.7515	4.7604	4.7894	11.93143
6.9200	-3.9900	5.1533	5.1745	5.1958	5.2588	12.73209
6.9200	-3.9900	5.6376	5.6762	5.7142	5.8239	13.68523
6.9200	-3.9900	6.2183	6.2808	6.3421	6.5171	14.83924
6.9200	-3.9800	3.0047	2.9754	2.9491	2.8839	8.60752
6.9200	-3.9800	3.1729	3.1460	3.1219	3.0623	8.92681
6.9200	-3.9800	3.3598	3.3358	3.3144	3.2619	9.28244

IF RESOLUTION AND RECOGNIZABILITY ARE IMPORTANT TO YOU,
 WE WOULD SUGGEST THAT YOU USE THE NEW TD 8484 VIDICON
 IN YOUR TELEVISION CAMERA.

MANUFACTURED BY

GENERAL ELECTRODYNAMICS CORPORATION

4430 FOREST LANE • GARLAND, TEXAS

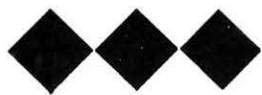

All-Channel Numeric Display

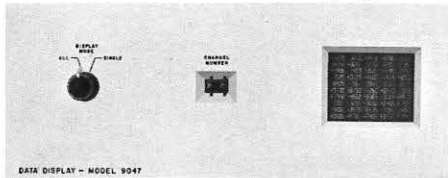

Systems Engineering Laboratories, Ft. Lauderdale, Fla., offers a standard all-channel data display, Model 9047, which provides the numeric value of each data channel on a 5-in.-diam. CRT. It allows the operator to observe all channel values in decimal form simultaneously, to assess quickly the system operation and to determine if all channels are functioning properly.

This option can be used in lieu of a single-channel display, yet provides a powerful tool for monitoring all data channels simultaneously. In addition to displaying all 50 channels in numeric form, a front panel switch selects either "all channel" or "single channel" operation. In the single-channel mode, the numeric value is enlarged to allow viewing from a distance. In the "all channel" mode, the data which has been digitized is gated to the display at a rate to allow refreshing of the display at a rate of at least 60 cps.

Circle Reader Service Card No. 47

Range Time Decoder

A versatile and compact range time decoder which synchronizes input time and system time within 40 microsecs. has been

NEW! COMPLETE PACKAGE RANDOM ACCESS PROJECTION SYSTEMS

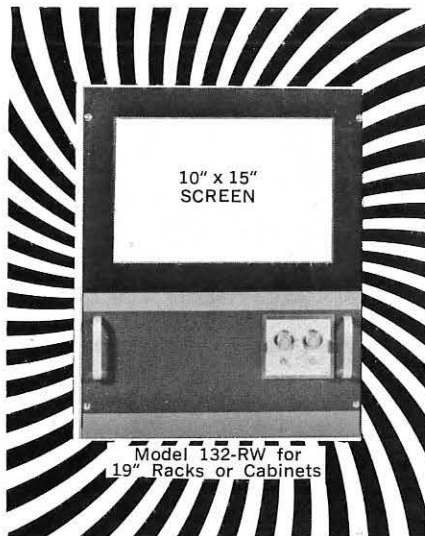

100 frame 35mm filmstrip
Dial or pushbutton control
0.25 to 3.5 second access time

Phone: 319-323-9729



**Mast Development
Company** Davenport,
Iowa 52803

Circle Reader Service Card No. 48

announced by The Roback Corp., Hunting-ton Valley, Pa. Designated Model TRC-505, it is only 14 in. high x 17 in. deep x standard 19-in. rack width. It accepts both IRIG and AMR time codes. Time of year is decimally displayed in days, hours, minutes, seconds, and tenths of seconds by an ultra-reliable, high-accuracy counter driven by an integral crystal oscillator.

Time of day is displayed in 17-bit binary form with 1 second granularity. All data is updated each time frame within 40 microsecs. of the "on time" signal. A 4 microsecond guard pulse occurs 1 microsecond before any data transition. Power requirements are 115 v ac $\pm 10\%$, 60 cps, 7 amps. A compact power supply, designated as Model TRC-301 and available as a separate unit, occupies only 5 1/4 in. of panel space.

Circle Reader Service Card No. 49

Single-Decade Counter

Hengstler Numerics Inc., Palisades Park, N.J., is offering a new FR 967 single-decade counter which incorporates "roller" contacts to provide longer life and higher speeds. Two flush-printed circuit boards provide accurate electric transfer, reset, and straight decimal electric readout. Rhodium-plated circuits used in conjunction with the flush design insure long board life and overall counter life.

The application of hard-gold plated rolling ball contacts, utilizing precision-ground balls that are spring loaded to maintain the proper contact pressure and roll over the circuit board surfaces, provide continuous positive contact even after prolonged use. It is capable of 50 counts/sec. and has a life expectancy in excess of 200 million actuations.

Circle Reader Service Card No. 50

Rotating Deflection Yoke

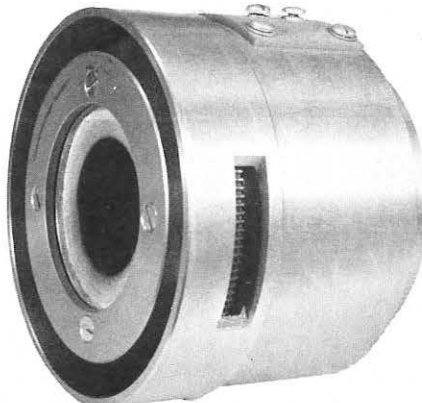

CELCO, Mahwah, N.J. announces immediate delivery of its new rotating deflection yoke for high-resolution PPI scans. Features include ball bearings, silver slip-rings, encapsulated coils and high precision gears. A wide range of inductances is offered. Distributed, low-capacitance windings assure fast rise and recovery times. Minimum spot shift is achieved by the use of unusual magnetic materials. Two axis rotating yokes are available on special order.

Circle Reader Service Card No. 51

12-Digit BCD Recorder

Adtrol Electronics Inc., Philadelphia, Pa., has announced a Model BCD-12 Photocorder, which records up to 12 digits of

binary-coded-decimal data directly onto motion picture film at the exact instant of the filmed event. The information is recorded in each frame of either 35- or 70-mm film at rates to 2500 frames/sec., according to Adtrol. The firm emphasizes time savings possible by utilizing support data recording on the film, which eliminates difficulties in extrapolating data from several recording sources correlated to the film.

The BCD-12 recording head is mounted within the moving film camera and interconnected to electronics by cable. Timing is provided by an internal 1000-cps time-base generator with a reset function for zero reference starting. Up to six digits of time are recorded frame-by-frame; the remaining six digits can be used for external data, and are applied through a special input connector.

Circle Reader Service Card No. 52

Multiple Message Switch

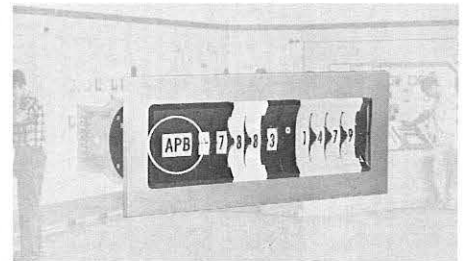

EECoSwitch Div. of Engineered Electronics Co., Santa Ana, Calif., has introduced a new double-width rotary thumbwheel switch for multiple message visual display. It is available with up to 12 index positions in both sealed (300 series) and unsealed (400 series) models.

It is available in one- and two-pole decimal, voltage divider, various BCD and many other standard switch codes. Units are individually replaceable and each one has single circuit board termination for either wire or connector termination. Potential applications foreseen include function selection, tracking position correlators, circuit selection identification, etc. Quantity of word lettering is limited to operator ability to read the dial. Message readout switch units may be expanded up to 20 stations as standard.

Circle Reader Service Card No. 53

Integrated Decade Counter

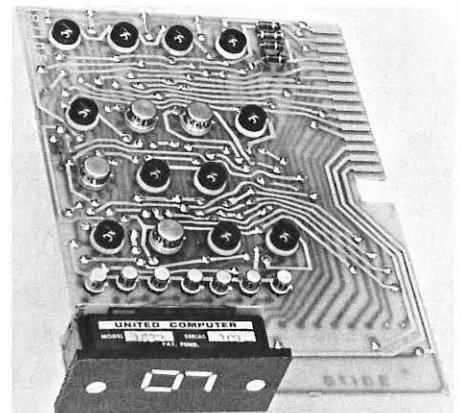

United Computer Co., Phoenix, Ariz., has announced a new Model F1832 integrated circuit decade counter which features dual lamps in each display segment

INFORMATION DISPLAY, JANUARY/FEBRUARY, 1966

for maximum life and reliability. Electrical outputs include 10-line, BCD, and analog staircase. Frequency response exceeds 3 megacycles. Fifteen integrated circuits provide maximum reliability. Single or dual preset knobs are available as an option.

An in-plane 7-segment display is provided with 100,000-hr. lamps. The decade can be reset to any number from 0 to 9, rather than reset to zero. Supply voltage is 3 to 4 v @ 0.46 w for dc logic, and 5 v ac for lamps. The size is 1 in. wide, 4 in. high by 5 in. deep, and weight is 4 oz.

Circle Reader Service Card No. 54

Remote Positioning Device

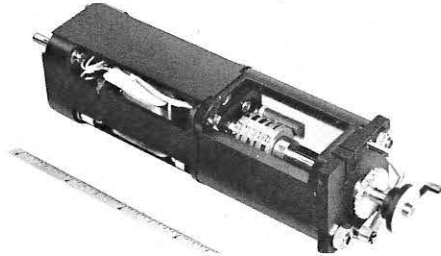

Occo Manufacturing Corp., South Hackensack, N.J., has developed a low-power, long-life remote positioning device now being introduced in quantity. Characteristics include: high repetition rate (60 steps/second); low signal drain (2 ma at 26 v required from input); low power consumption (5 watts max. at 26 v dc); accurate shaft positioning ($\pm 0.15^\circ$ max. angular error); long life - 100 million steps min. (24 position unit).

Specific applications are said to include digital-to-analog conversion, events counting and control, readout devices, data projection, remote switch positioning, and telemetry. It is ideally suited for use as a replacement for rotary solenoid devices when power consumption, life, and radiated electrical noise are factors in actuator selection, according to the manufacturer.

Circle Reader Service Card No. 55

CRT/Microfilm Plotting

California Computer Products Inc., Los Angeles, has developed a new CRT/microfilm plotting system which the firm claims plots 300 times faster than a standard Cal-Comp Model 565 ink-on-paper digital incremental plotter. Termed Model 835, it is described as a true digital incremental plotter, designed for off-line use with magnetic tape units Models 760, 770, and 780. Plotting is accomplished with the tape unit in the search mode, at a tape speed of 60 inches/sec. It can plot a complete 2400-ft. reel of tape in 8 mins.

The plotting system may be used in a time-shared configuration with other on-line requirements, and is capable of accepting input commands at rates up to 100,000 characters/sec. Incremental plot commands produce deflection of the CRT electron-beam. The CRT display is transmitted through the camera lens system and automatically recorded on 35-mm microfilm at speeds up to five frames/sec. Exposed film may be processed to produce either positive or negative transparencies for direct viewing or photographic printing.

Circle Reader Service Card No. 56

INDICATORS, READOUTS for INTEGRATED CIRCUITS

CONTROL INCANDESCENT AND NEON LAMPS FROM LOW LEVEL SIGNALS OF MICROCIRCUITS

New TEC-LITE transistor controlled "M" Series indicators and readout devices are designed to operate directly from the output signal levels of many integrated circuit packages currently available to designers. Input impedances of TEC-LITE indicators and readouts are specified to allow calculation of fan-out and fan-in according to the integrated circuit manufacturer's specifications.

High current and voltage problems typical of incandescent and neon lamps are solved with TEC-LITE transistor controlled indicators and digital display decoder-drivers. Low level signals present in integrated circuits switch lamps and elements of neon display tubes on and off.

TEC-LITE indicators also offer memory as well as self-contained momentary contact switches, isolated from lamp circuitry, to conserve panel space. A wide range of lens colors and terminal types are available. Digital display lamp drivers also provide memory and decoder functions from a variety of input codes.



"M" Series Indicator prices begin at \$3.30 (100-499 Qty.) Size: 9/16" dia. up to 2 3/4" long, backpanel.

MMTL Series

"M" Series Readout prices start at \$32.35 (30-99 Qty.) Characters displayed on 1" centers

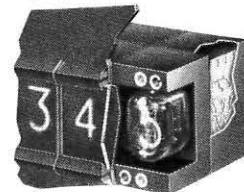

MTNR Series

For quotation on a specific circuit application please specify manufacturer and type of integrated circuit involved and specify voltage and current of logic levels.

In addition to the "M" Series for integrated circuits, TEC also offers a complete line of transistor controlled devices for solid state systems using discrete components. For complete information on TEC-LITE Indicator Devices designed and built by the originator and world's largest manufacturer of transistor controlled indicators, contact your TEC-REP or write directly to:



INDICATING DEVICES

Originator of
Transistorized
Indicating Devices

Transistor Electronics Corporation

Box 6191 Minneapolis, Minnesota 55424 Phone (612) 941-1100

TEC-LITE Indicators are protected by one or more of the following patents: U.S. Pat. Nos. 2,985,874; 3,041,499; 3,116,480; Australian Pat. No. 244,756; Belgian Pat. Nos. 604,246 & 637,379; Canadian Pat. No. 686,506; French Pat. No. 1,291,911; Italian Pat. No. 674,414; Swiss Pat. No. 376,541; British and German patents pending.

THE KEY TO YOUR MAGNETIC SHIELDING Problems...

*Seamless tubing
construction*



Hydrogen annealing for maximum permeability



Fabrication in all types of MU metal materials including . . .

- Magnaloy
- Westinghouse Hypernik
- Hypernom
- Carpenter 49
- HY-MU 80
- Mu Metal



Customized fabrication to your exact engineering specifications



Ultimate in attenuation -60/-80 db

We have perfected the art of seamless-tube construction in magnetic shielding components at a price comparable to or lower than the "old-fashioned" overlapped welded seam designs

QUOTATIONS submitted on request per your blue print specifications for . . .

- ENGINEERING SAMPLES
- PROTOTYPES
- PRODUCTION RUNS

SEND FOR ILLUSTRATED BROCHURE

Magnetic **RADIATION
LABORATORIES, INC.**

7325 W. North Ave. - River Forest, Ill.
PHONE (Area Code 312) 771-7172

Circle Reader Service Card No. 58

New Literature

BuWeps Synchros

A new data sheet on Size 11 BuWeps synchros is now available for designers of servosystems who need a device that transduces shaft angle to electrical signals and vice versa. Available off-the-shelf are types CT (control transfer), CX (control transmitter), and CDX (control differential). From IMC Magnetics Corp., Westbury, N.Y.

Circle Reader Service Card No. 59

CRT to Hard Copy

A comparative presentation of photographic techniques for generating hard copy from CRT-displayed data has just been published by Photomechanisms Inc., Huntington Station, Long Island, N.Y. The four-page illustrated folder discusses hard-copy requirements, describes various photographic techniques, and offers criteria for application of specific techniques to specific problems. A variety of processes is discussed.

Circle Reader Service Card No. 60

Digital Computers

Two new brochures detailing the operation and programming of the Electronic Associates Inc. EAI 8400 digital computer are now available from the West Long Branch, N.J. firm. The 16-pge. Bulletin No. DC 65033 describes the system and system operation, including a summary of computer characteristics, and explanation of system hardware. The 14-pge. Bulletin No. DC 65024 is devoted to the EAI 8400 programming system. EAI is a scientific computing system introduced last fall at FJCC; it features a highly sophisticated digital computer with ultrafast floating-point operation, 32-bit word length, and 64,000-word storage.

Circle Reader Service Card No. 61

PEL Submin Lights

Dialight Corp., Brooklyn, N.Y., has issued a catalog of its subminiature indicator lights for translucent panel edge lighting. The 1- and 2-terminal edge-lighting-assemblies are for use with MIL-P-7788 plastic plate panels that meet applicable requirements of MIL-L-7806 and MS25010, Revision D. Also listed are one-terminal light emitting and insert lens top assemblies.

Circle Reader Service Card No. 62

Electroluminescent Displays

Electroluminescent display devices designed for aircraft, submarine and a variety of military applications are described in a new brochure by Sylvania Electric Products Inc., a GTEC subsidiary, of Waltham, Mass. Compiled by the Sylvania Electronic Systems Div., the pamphlet includes alphanumeric, bar graph, bistable, and crossed-grid displays.

Circle Reader Service Card No. 63

Listing of 1000 Switches

Micro Switch Div., Honeywell Inc., Freeport, Ill., has issued a new General Catalog 50 which lists more than 1000 different switches. The 64-pge. catalog gives comprehensive coverage of mechanically-operated

switches plus information on manually-operated and environment-proof types. Types included are limit, enclosed, proximity, explosion-proof, basic, miniature basic, manually-operated switches for lighted control panels, pushbuttons, hermetically sealed, and others.

Circle Reader Service Card No. 64

Decade Counters

United Computer Company, Phoenix, Ariz., has issued Technical Bulletin R75 which describes a line of high-speed integrated-circuit decade counters that accept from 1 count/sec. to 3 million counts/sec., have front-panel preset switches, and operate on as little as 1 watt power. Photos and specs are included.

Circle Reader Service Card No. 65

Time Code Generator

Electronic Engineering Co. of California, Santa Ana, has published an illustrated 8-pge. catalog describing its EECO 911 integrated circuit 11 format Time Code Generator. NASA, AMR, and IRIG standard time code formats are also included.

Circle Reader Service Card No. 66

Mechanical Motion Display

Theta Instrument Corp., Saddle Brook, N.J., manufacturers of digital displays, have announced a 12-pge. 2-color engineering bulletin which fully describes mechanical and electronic modules that convert mechanical motion into a remote digital display. Theory of operation as well as applications of the product, designated Decittrak system, is discussed in detail, including illustrations. Full specs and prices are included.

Circle Reader Service Card No. 67

CRT Displays

Digital Equipment Corp., Maynard, Mass., has announced a 4-pge., 2-color brochure which gives specs and applications information on four CRT displays and a fast light-pen designed to improve the operator's control over a computer. Included are Type 340 Incremental Display combining massive line-generation with subrouting; Type 338 Programmed Buffered Display as independent system or buffered satellite terminal; Type 30 Precision Display, for point-plotting; and Type 34 Oscilloscope Display for those without a 17-in. screen requirement.

Circle Reader Service Card No. 68

Circular Polarizer Brochure

Polaroid Corp., Cambridge, Mass., has published a brochure entitled "Polaroid® Circular Polarizer for Contrast Improvement." It describes in detail how polarizing filters work with readout devices such as the Burroughs Nixie indicator tubes. Polaroid Corp. states the polarizers' ability to absorb back reflection has caused the readability of Nixie-type displays to be vastly improved. Circular polarizers work in one direction only. Burroughs offers complete assemblies containing 0.030-in.-thick Polaroid Type HACP24 amber circular polarizers.

Circle Reader Service Card No. 69

on the move

(Continued from page 60)

Patrick F. Gambuti has been elected VP/Mktg., General Electrodynamics Corp.

W. A. Gannon has been named Northeast area mgr. by Systems Engineering Laboratories, and **Frank A. Dolan** has been appointed area mgr. for the Mid-Atlantic States.

Selig Gertzis has been appointed dir., semiconductor enrg., Amperex Electronic Corp., according to **Frank Randall**, pres.

James L. Pyle has been promoted to asst. to the pres. of California Computer Products Inc., and **Richard I. Tanaka** has been appointed consultant to the pres.

Cameron B. Forrest has joined Tasker Instruments Corp., Van Nuys, Calif., as executive engr., reporting to **David J. Green**, VP.

John C. Lindley has been promoted to the staff of **George T. Scharffenberger**, sr. VP in charge of Litton Industries' Systems Group. Litton has also named **Richard M. Landman** director of sls. for its Guidance and Control Systems Div., and **Benjamin J. Handy** as technical mgr., avionics/fire control computer applications, Data Systems Div.

Honeywell Inc. has promoted several persons to managerial positions in its East Coast mktg. organization. Named sls. mgrs. were **Wilbur W. Castor**, Milford, Conn.; **Bernard M. Kearney**, Hartford, Conn.; **William C. Stancik**, Washington, D.C. cmcl. sls.; and **Irwin Findling** has been named mgr., national accounts group in the NYC regional hq. **James H. Mead** has been named mgr. of customer services at Wellesley Hills, Mass., and **Don E. Robinson** has been named mgr. of programming systems there. **Richard K. Hurley** has been named mgr. of the Electronic Data Processing Div.'s NY-West sls. office.

Arnold J. Burke has been named prod. mgr., ITT Data & Information Systems Div., and **Edward J. Whalen** has been made exec. asst. to the pres. of ITT Federal Laboratories.

Fairchild DuMont Electron Tubes Div. has named **Joseph Burns** to head its Display Devices Dept., and **Guy F. Barnett** will manage CRT enrg. The firm's Scientific Instruments Div. has appointed **Pat Zagaria** Eastern regional mgr., and **Bert E. Saunders** mgr. of the Central region. **George Rakonitz** had previously been appointed mgr. of the Western region.

The Electronic Components Group of Sylvania Electric Products Inc. has named **J. Edward Schlener** sls. mgr. of the Northeastern area.

How can you get the most squint-proof detail on closed-circuit TV?



Unretouched photo of monitor screen

Granger Associates has the answer

now

G/A's new high-resolution TV system lets you read a letter or digit occupying only 1/15,000 of the picture area. You can view broad scenes—like a situation display, an airport runway, or a bank of panel meters—and see all the critical details. Or you can put an entire letter-size document on the screen and read any part. Series V1000 TV systems use as many as 1225 scanning lines and a 30 Mc video bandwidth to produce pictures with four times the clarity of conventional 525-line, 8 Mc systems. Get in touch with G/A for the most advanced closed-circuit TV systems available anywhere today.



66

AN EQUAL OPPORTUNITY EMPLOYER

1601 California Ave., Palo Alto, California / Telephone: 321-417 5/ TWX: 910-373-1291
Granger Associates Ltd., Fox Oak (Flat), Seven Hills Road, Walton-on-Thames, Surrey, England / Weybridge 44842

Circle Reader Service Card No. 59

ID Advertisers

AMPEX	56	GENERAL ELECTRODYNAMICS	65	MACBETH CORPORATION	10
BAIRD-ATOMIC	28	Agency: Evans, Young & Wyatt		Agency: Truchess Design	
Agency: Van Christo Associates		GENERAL PRECISION/Link Group	5	MAGNETIC RADIATION LABS, INC.....	68
BENSON-LEHNER CORP.	7	Agency: Gaynor and Ducas		Agency: W. H. Van Riper & Assoc.	
Agency: Bonfield Associates, Inc.		GRANGER ASSOCIATES	69	MAST DEVELOPMENT CO.	66
BETA INSTRUMENTS	8	Agency: West Associates		Agency: Paul Mendy	
Agency: Simonds, Payson Company, Inc.		HUGHES AIRCRAFT COMPANY	55	MASTER SPECIALTIES	19
BURROUGHS CORP.	3	Agency: Foote, Cone and Belding		Agency: William E. Wilson	
Agency: Conti Advertising Agency, Inc.		I B M CORPORATION	15	MICRO SWITCH	14
CALIFORNIA COMPUTER	13	Agency: Marsteller		Agency: Batten, Barton, Durstine & Osborn	
Agency: Advertisers Production Agency		INDUSTRIAL ELECTRONIC ENGINEERS	21	MILGO ELECTRONIC CORP.	9
CEDAR ENGINEERING	58	Agency: Gumpertz, Bentley & Dolan		PERFECTION MICA CO.	63
Agency: Colle & McVoy		INFORMATICS	38	Agency: Burton Browne	
CELCO (Constantine Engineering		Agency: Faust/Day		RAYTHEON	37
Labs.)	17	INFORMATION DISPLAYS, INC.	53	Agency: Fuller & Smith & Ross	
Agency: Stano		Agency: George Taubert		SPECTRA-PHYSICSInside Front Cover	
CONRAC (Div. of Giannini Controls)....	18	JAY-EL PRODUCTS	60	Agency: Hal Lawrence	
Agency: Faust/Day		Agency: Lynn-Western		SPINDLER & SAUPPE	48
DATA DISPLAY, INC.	Back Cover	KOLLSMAN		Agency: Balsam	
Agency: Klau-Van Pietersom-Dunlap		INSTRUMENTS Inside Back Cover		SYNTRONIC INSTRUMENTS	6
DIALIGHT CORP.	4	Agency: Gaynor & Ducas		Agency: Burton Browne	
Agency: H. J. Gold		LITTON INDUSTRIES/Data		TRANSISTOR ELECTRONICS	67
FAIRCHILD DUMONT LABS.	52	Systems Div.	16	Agency: Stevenson and Assoc.	
Agency: Conti		Agency: West, Weir & Bartel		TUNG-SOL ELECTRONICS	57
GAMMA SCIENTIFIC	60	LITTON INDUSTRIES/Electron		Agency: E. M. Freystadt Assoc.	
Agency: Barnes Chase		Tube Div.	59	VIDEO COLOR CORP.	58
		Agency: West, Weir & Bartel			

SID Sustaining Members

AEROSPACE CORPORATION
SAN BERNARDINO, CALIFORNIA

CELCO
(CONSTANTINE ENGINEERING LABS. CO.)
MAHWAH, NEW JERSEY

COMMUNICATIONS & ELECTRONICS
DIV.

PHILCO CORPORATION
A SUBSIDIARY OF FORD MOTOR COMPANY
WILLOW GROVE, PENNSYLVANIA

CONRAC DIVISION
GIANNINI CONTROLS CORP.
GLEN DORA, CALIFORNIA

FAIRCHILD DUMONT
LABORATORIES
CLIFTON, NEW JERSEY

HUGHES AIRCRAFT COMPANY
VACUUM TUBE PRODUCTS DIV.
OCEANSIDE, CALIFORNIA

ITT FEDERAL LABORATORIES
A DIVISION OF INTERNATIONAL TELEPHONE
AND TELEGRAPH CORPORATION
NUTLEY, NEW JERSEY

LING TEMCO VOUGHT
MILITARY ELECTRONICS DIVISION
DALLAS, TEXAS

NAC CAMERA SERVICE COMPANY
7-1 GINZANISHI
CHUO-KU, TOKYO, JAPAN

RADIATION, INC.
MELBOURNE, FLORIDA

STROMBERG CARLSON CORP.
DATA PRODUCTS
SAN DIEGO, CALIFORNIA

SYLVANIA ELECTRONIC TUBES
DIV., SYLVANIA ELECTRONIC PRODUCTS, INC.
SENECA FALLS, NEW YORK

TELEVISION ELECTRONICS DIVISION
DOUGHBOY INDUSTRIES
WHEELING, ILLINOIS

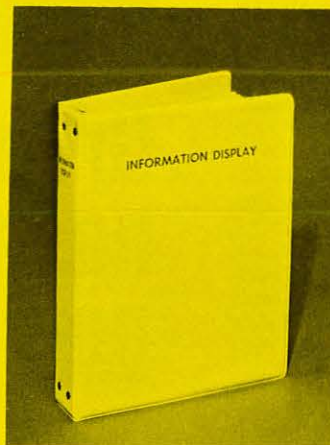

**A HANDY,
HANDSOME
BINDER FOR
12 ISSUES OF
INFORMATION
DISPLAY**

(a two-year supply)

\$4.50

Now you can build an **Information Display** reference library and retain bi-monthly issues of the Journal **intact** in a beautiful gold-and-white vinyl binder. Twelve flexible steel rods hold a two-year supply of ID, permitting easy entry and removal without damage to your copies. Gold lettering on the binding and front cover provides ready identification. Reinforced stiffening throughout and durable, easy-to-clean vinyl covering make this binder a handsome addition to your office or home library. Order your binder today. Send check or money order to:

INFORMATION DISPLAY

647 N. Sepulveda Blvd., Bel Air, Los Angeles, Calif. 90049



Kollsman introduces dataKrome™: the first simultaneous four-color data display projector

Until now, command and control systems required four projectors to display four colors; today, a single dataKrome scribing projector presents the four colors in one synchronized, simultaneous display. It provides brilliant, easy-to-follow, real-time data at about one-fourth the cost of equivalent four-color scribing systems.

The dataKrome projector is completely modular and conforms to Mil-Specs. It can be used with other plotting, background and spotting projectors. Projected data can include track information, target identification, event marking and symbols.



Available now, dataKrome is a major innovation in advanced display systems—performing as no other single projector can. For details, write to Display Systems, Kollsman Instrument Corporation, 575 Underhill Blvd., Syosset, New York 11791.

Kollsman 
INSTRUMENT CORPORATION
ELMHURST, NEW YORK 11373

Subsidiaries ■ Kollsman Motor Corporation ■ Kollsman Instrument Ltd. (Great Britain) ■ Kollsman System Technik (Germany)

For a better "meeting of minds" between man and computer... Control Data offers visual displays that flash current facts to people the second they're needed



now everybody can have today's data today



You now can "talk" directly to Control Data computers and get answers back instantly—in plain English! Think what the CONTROL DATA® 210 Visual Display unit shown here lets you do. Type in a query. Read out your answer on the screen. This highly personal thinking aid extends your memory and communications faculties. Helps you keep abreast of rapidly changing conditions in complex operations. And the 210 Visual Display is just one of many new ways Control Data makes the world's most powerful computers people accessible—so that many can share a single central system simultaneously. Ask your Control Data representative for further details. Or write our Minneapolis address, Dept. LL-16.



CONTROL DATA
CORPORATION

8100 34th AVE. SO., MINNEAPOLIS, MINNESOTA 55440

Circle Reader Service Card No. 72